

EDAN

SE-1010

PC ECG

Version 2.0

CE₀₁₂₃

About this Manual

P/N: 01.54.106666-20

Release Date: June 2012

© Copyright EDAN INSTRUMENTS, INC. 2008-2012. All rights reserved.

Statement

This manual will help you understand the operation and maintenance of the product better. It is reminded that the product shall be used strictly complying with this manual. User's operation failing to comply with this manual may result in malfunction or accident for which EDAN INSTRUMENTS, INC. (hereinafter called EDAN) can not be held liable.

EDAN owns the copyrights of this manual. Without prior written consent of EDAN, any materials contained in this manual shall not be photocopied, reproduced or translated into other languages.

Materials protected by the copyright law, including but not limited to confidential information such as technical information and patent information are contained in this manual, the user shall not disclose such information to any irrelevant third party.

The user shall understand that nothing in this manual grants him, expressly or implicitly, any right or license to use any of the intellectual properties of EDAN.

EDAN holds the rights to modify, update, and ultimately explain this manual.

Responsibility of the Manufacturer

EDAN only considers itself responsible for any effect on safety, reliability and performance of the equipment if:

Assembly operations, extensions, re-adjustments, modifications or repairs are carried out by persons authorized by EDAN, and

The electrical installation of the relevant room complies with national standards, and

The instrument is used in accordance with the instructions for use.

Upon request, EDAN may provide, with compensation, necessary circuit diagrams, and other information to help qualified technician to maintain and repair some parts, which EDAN may define as user serviceable.

Terms Used in this Manual

This guide is designed to give key concepts on safety precautions.

WARNING

A **WARNING** label advises against certain actions or situations that could result in personal injury or death.

CAUTION

A **CAUTION** label advises against actions or situations that could damage equipment, produce inaccurate data, or invalidate a procedure.

NOTE

A **NOTE** provides useful information regarding a function or a procedure.

Table of Contents

Chapter 1 Safety Guidance	1
1.1 Intended Use.....	1
1.2 Warnings and Cautions.....	1
1.2.1 General Warnings	1
1.2.2 Li-ion Battery Care Warnings	4
1.2.3 General Cautions.....	5
1.2.4 Operation for Wireless System.....	5
1.2.5 Preparation and Operation Warnings (for Exercise ECG).....	6
1.2.6 Contraindications (for Exercise ECG)	7
1.3 List of Symbols	8
Chapter 2 Introduction.....	10
2.1 SE-1010 PC ECG System	10
2.2 DP12 ECG Sampling Box of Wired System.....	13
2.3 DX12 ECG Sampling Boxes of Wireless System.....	16
2.4 Features	19
Chapter 3 Assembling SE-1010 PC ECG System.....	21
3.1 Assembling Wired System	21
3.2 Assembling Wireless System	23
Chapter 4 Installing SE-1010 PC ECG Software.....	25
4.1 System Running Environment	25
4.1.1 Requirements on the Hardware of the PC.....	25
4.1.2 Requirements on the Software of the PC	25
4.2 About Installation Window	26
Chapter 5 Preparations Before Operation.....	27
5.1 Preparing the Patient	27
5.1.1 Instructing the Patient	27
5.1.2 Preparing the Skin.....	27
5.2 Connecting the Electrodes of Wired System.....	28
5.3 Connecting the Electrodes of Wireless System.....	29
5.4 Attaching Electrodes (for Resting ECG).....	29
5.4.1 Wilson Lead System.....	30
5.4.2 Frank Lead System.....	30
5.4.3 Attaching Electrodes to the Patient	31
5.5 Attaching Electrodes to the Patient (for Exercise ECG)	33

5.6 Inspection Before Test.....	35
5.7 Setting DX12 Transmitter (for Wireless System)	36
5.7.1 Keyboard Locking/Unlocking.....	38
5.7.2 Menu Settings	39
Chapter 6 Operation Instructions for Resting ECG.....	40
6.1 Viewing Lead Placement Information.....	41
6.2 Selecting a Patient Record to Start a New Test.....	42
6.3 Entering New Patient Information	44
6.3.1 Entering New Patient Information Manually.....	44
6.3.2 Entering Patient Information by Using a Bar Code Reader.....	47
6.4 Selecting Sampling Type.....	48
6.5 Sampling Resting ECG	48
6.5.1 Specifying Display Mode.....	49
6.5.2 Specifying Lowpass Filter.....	50
6.5.3 Specifying Gain.....	50
6.5.4 Specifying Speed.....	50
6.5.5 Recording ECG Data.....	51
6.5.6 Freezing and Previewing ECG.....	51
6.5.7 Stopping Sampling Data	52
6.5.8 Printing ECG Waves	53
6.6 Analyzing ECG Data.....	53
6.6.1 Analyzing Normal ECG	53
6.6.1.1 Viewing the Waveform.....	54
6.6.1.2 About the Average Template Window.....	56
6.6.1.3 About the Detail Information Window.....	58
6.6.1.4 About the Rhythm Wave Window.....	59
6.6.1.5 Previewing Normal ECG	59
6.6.2 Analyzing QT Dispersion.....	61
6.6.2.1 Editing Waveform on the QT Dispersion Screen.....	62
6.6.2.2 About QT Value.....	62
6.6.2.3 Previewing QT Dispersion.....	63
6.6.3 Analyzing Frequency ECG	64
6.6.3.1 About Two-lead Comparison Window	64
6.6.3.2 About 12-lead Power Spectrum Window.....	66
6.6.3.3 Previewing Frequency ECG.....	66
6.6.4 Analyzing High Frequency ECG	68

6.6.5 Analyzing HRV	70
6.6.5.1 Editing the HRV Data on the Analysis Screen.....	71
6.6.5.2 Editing the HRV Waveform in the Waveform Window	72
6.6.5.3 Previewing HRV	73
6.6.6 Analyzing HRT.....	74
6.6.7 Analyzing Vector ECG.....	76
6.6.7.1 Displaying Vector ECG with All Plane and All Loop.....	76
6.6.7.2 Displaying Vector ECG with Frontal Plane and QRS Loop	79
6.6.7.3 Displaying 3D Vector ECG.....	79
6.6.7.4 Previewing Vector ECG	80
6.6.8 Analyzing Time Vector ECG.....	81
6.6.9 Analyzing Signal Averaged ECG	83
6.6.9.1 About the Time Domain Window	83
6.6.9.2 About the Frequency Domain Window.....	84
6.6.9.3 Previewing Signal Averaged ECG	85
6.6.10 Printing ECG Reports	86
6.6.11 Saving ECG Reports	86
6.7 Sampling STAT ECG	87
Chapter 7 Operation Instructions for Exercise ECG	88
7.1 Viewing Lead Placement Information.....	88
7.2 Selecting a Patient Record to Start a New Test.....	89
7.2.1 Setting Target HR.....	90
7.2.2 Setting Normal BP	90
7.2.3 Setting a Protocol.....	90
7.2.4 Setting Post J.....	90
7.2.5 Setting BP Sampling Mode	91
7.2.6 Setting BP Triggering Mode	91
7.2.7 Setting Auto Printing.....	91
7.3 Entering New Patient Information	91
7.4 Pre-sampling ECG	92
7.5 Pretest Phase.....	93
7.5.1 Viewing the Heart Rate and the Blood Pressure	94
7.5.2 Viewing Other Information	95
7.5.3 Editing the Waveform	95
7.5.4 Printing the Pretest Report	97
7.6 Exercise Phase.....	97

7.7 Recovery Phase	98
7.8 Exiting the Exercise Test.....	98
7.9 About Analysis Screen	99
7.9.1 About Summary Screen.....	99
7.9.2 About ST Analysis Screen.....	101
7.9.3 About All View Review Screen.....	103
7.9.4 About Trend Screen.....	105
7.9.5 About ECG Strip Screen	106
7.9.6 Previewing ECG Reports	106
7.9.7 Printing ECG Reports	107
7.9.8 Saving ECG Reports	107
7.9.9 Exiting the Analysis Screen	107
Chapter 8 Processing Patient Records	108
8.1 Searching Patient Records.....	108
8.2 Modifying Patient Records	110
8.3 Deleting Records.....	111
8.3.1 Deleting Patient Records.....	111
8.3.2 Deleting Examination Records of a Patient	111
8.4 Selecting a Patient Record	111
8.5 Merging Examination Records	112
8.6 Comparing Two Examination Records	112
8.7 Importing ECG Data into the Data Manager Screen	114
8.8 Exporting ECG Data from the Data Manager Screen.....	116
8.9 Viewing an Examination Record.....	117
Chapter 9 Configuring the System	118
9.1 Basic Information Setup.....	118
9.1.1 Setting Basic Information	119
9.1.2 Setting ID Mode.....	120
9.1.3 Setting Language.....	120
9.1.4 Specifying the Storage Path of the ECG Data	120
9.2 Sample Setup.....	121
9.2.1 Setting Filter.....	121
9.2.2 Setting Sampling Time	122
9.2.3 Others	122
9.2.4 Selecting Auto Printing When Detecting Arrhythmia.....	123
9.2.5 Setting Background Grid	123

9.2.6 Setting Anti-aliasing	123
9.2.7 Selecting QRS Voice	123
9.2.8 Selecting Sequence Mode When Sampling	123
9.3 Device Setup	124
9.3.1 Setting Sampling Device	124
9.3.2 Setting Device Type/Mode	125
9.3.3 Setting COM Port of Sample/Treadmill/BP Monitor	125
9.3.4 Setting a Protocol	125
9.3.4.1 Creating a New Protocol	126
9.3.4.2 Modifying a Protocol	127
9.3.4.3 Deleting a Protocol	128
9.3.4.4 Restoring the default protocol	128
9.3.5 Advanced Setup	128
9.3.5.1 Setting Access Network	128
9.3.5.2 Setting Barcode	129
9.4 Print Setup	131
9.4.1 Choosing Patient Information to be Printed	131
9.4.2 Choosing Diagnosis Information to be Printed	132
9.4.3 Setting Rhythm Lead	133
9.4.4 Defining Printing Format	133
9.5 Output File Setup	134
9.5.1 File Naming	134
9.5.2 Setting PDF/JPG	135
9.5.3 Setting SCP	135
9.5.4 Setting FDA-XML	135
9.5.5 Setting DICOM	136
9.5.6 Specifying the Output Path	136
9.6 Data Maintenance Setup	136
9.6.1 Database Rebuild	137
9.6.2 Database Backup	137
9.7 GDT Setup	139
9.8 Other Setup	140
9.8.1 Setting Unit and Color	141
9.8.2 Setting System Password	141
9.8.3 Setting Wave Width and Grid Width	141
9.9 Modifying the Glossary	142

Chapter 10 Hint Information	144
Chapter 11 Cleaning, Care and Maintenance	146
11.1 Cleaning and Maintaining the Treadmill.....	146
11.2 Cleaning and Maintaining the Patient Cable and Reusable Electrodes	146
11.3 Disinfection	147
Chapter 12 Accessories	148
Chapter 13 Warranty & Service	150
13.1 Warranty	150
13.2 Contact information	150
Chapter 14 Recommended Optional Accessories	151
Appendix 1 Technical Specifications	153
A1.1 Safety Specifications	153
A1.2 Environment Specifications	153
A1.3 Physical Specifications.....	154
A1.4 Power Supply Specifications.....	154
A1.5 Performance Specifications	154
Appendix 2 EMC Information	157
Appendix 3 Abbreviation	162

Chapter 1 Safety Guidance

This chapter provides important safety information related to the use of SE-1010 PC ECG.

1.1 Intended Use

SE-1010 PC ECG is a PC-based diagnostic tool intended to acquire, process and store ECG signals from adult and pediatric patients undergoing stress exercise test or resting test. SE-1010 PC ECG is intended to be used only in hospitals and healthcare facilities by doctors and trained healthcare professionals. The cardiogram recorded by SE-1010 PC ECG can help users to analyze and diagnose heart disease. However the ECG with measurements and interpretive statements is offered to clinicians on an advisory basis only.

WARNING

1. This system is not designed for intracardiac use or direct cardiac application.
 2. This system is not intended for home use.
 3. This system is not intended for treatment or monitoring.
 4. This system is intended for use on adult and pediatric patients only.
 5. The results given by the system should be examined based on the overall clinical condition of the patient, and they can not substitute for regular checking.
-

1.2 Warnings and Cautions

To use the system safely and effectively, firstly be familiar with the operation method of Windows and read the user manual in detail to be familiar with the proper operation method for the purpose of avoiding the possibility of system failure. The following warnings and cautions must be paid more attention to during the operation of the system.

1.2.1 General Warnings

WARNING

1. The system is intended to be used by qualified physicians or personnel professionally trained. They should be familiar with the contents of this user manual before operation.
 2. Only qualified service engineers can install this equipment, and only service engineers authorized by the manufacturer can open the shell.
-

WARNING

3. **EXPLOSION HAZARD** - Do not use the system in the presence of flammable anesthetic mixtures with oxygen or other flammable agents.
 4. **SHOCK HAZARD** - The power receptacle must be a hospital grade grounded outlet. Never try to adapt the three-prong plug to fit a two-slot outlet.
 5. Only the patient cable and other accessories supplied by the manufacturer can be used. Or else, the performance and electric shock protection can not be guaranteed. The system has been safety tested with the recommended accessories, peripherals, and leads, and no hazard is found when the system is operated with cardiac pacemakers or other stimulators.
 6. Make sure that all electrodes are connected to the patient correctly before operation.
 7. Ensure that the conductive parts of electrodes and associated connectors, including neutral electrodes, do not come in contact with earth or any other conducting objects.
 8. If reusable electrodes with electrode gel are used during defibrillation, the system recovery will take more than 10 seconds. The manufacturer recommends the use of disposable electrodes at all times.
 9. Electrodes of dissimilar metals should not be used; otherwise it may cause a high polarization voltage.
 10. The disposable electrodes can only be used for one time.
 11. Do not touch the patient, bed, table or the equipment while using the ECG together with a defibrillator.
 12. Do not touch accessible parts of non-medical electrical equipment and the patient simultaneously.
 13. The use of equipment that applies high frequency voltages to the patient (including electrosurgical equipment and some respiration transducers) is not supported and may produce undesired results. Disconnect the patient data cable from the electrocardiograph, or detach the leads from the patient prior to performing any procedure that uses high frequency surgical equipment.
 14. Fix attention on the examination to avoid missing important ECG waves.
 15. **SHOCK HAZARD** - Don't connect non-medical electrical equipment, which has been supplied as a part of the system, directly to the wall outlet when the non-medical equipment is intended to be supplied by a multiple portable socket-outlet with an isolation transformer.
-
-

WARNING

16. **SHOCK HAZARD** - Don't connect electrical equipment, which has not been supplied as a part of the system, to the multiple portable socket-outlet supplying the system.
 17. Do not connect any equipment or accessories that are not approved by the manufacturer or that are not IEC/EN 60601-1-1 approved to the system. The operation or use of non-approved equipment or accessories with the system is not tested or supported, and system operation and safety are not guaranteed.
 18. Any non-medical equipment (such as the external printer) is not allowed to be used within the patient vicinity (1.5m/6ft.).
 19. Do not exceed the maximum permitted load when using the multiple portable socket-outlet(s) to supply the system.
 20. Multiple portable socket-outlets shall not be placed on the floor.
 21. Do not use the additional multiple portable socket-outlet or extension cord in the medical electrical system, unless it's specified as part of the system by manufacturer. And the multiple portable socket-outlets provided with the system shall only be used for supplying power to equipment which is intended to form part of the system.
 22. Accessory equipment connected to the analog and digital interfaces must be certified according to the respective IEC/EN standards (e.g. IEC/EN 60950 for data processing equipment and IEC/EN 60601-1 for medical equipment). Furthermore all configurations shall comply with the valid version of the standard IEC/EN 60601-1-1. Therefore anybody, who connects additional equipment to the signal input or output connector to configure a medical system, must make sure that it complies with the requirements of the valid version of the system standard IEC/EN 60601-1-1. If in doubt, consult our technical service department or your local distributor.
 23. Connecting any accessory (such as external printer) or other device (such as the computer) to this electrocardiograph makes a medical system. In that case, additional safety measures should be taken during installation of the system, and the system shall provide:
 - a) Within the patient environment, a level of safety comparable to that provided by medical electrical equipment complying with IEC/EN 60601-1, and
 - b) Outside the patient environment, the level of safety appropriate for non-medical electrical equipment complying with other IEC or ISO safety standards.
 24. All the accessories connected to system must be installed outside the patient vicinity, if they do not meet the requirement of IEC/EN 60601-1.
-
-

WARNING

25. You should purchase computer, printer, treadmill, ergometer, BP monitor and bar code reader from the manufacturer. Otherwise, the manufacturer will not be held responsible for the maintenance of the PC hardware, operating system and other accessories.
 26. If multiple instruments are connected to a patient, the sum of the leakage currents may exceed the limits given in the IEC/EN 60601-1 and may pose a safety hazard. Consult your service personnel.
 27. Connecting to other devices may decrease the antistatic gradation of the system during operation.
-
-

1.2.2 Li-ion Battery Care Warnings

WARNING

1. Improper operation may cause the internal li-ion battery (hereinafter called battery) to be hot, ignited or exploded, and it may lead to the decrease of the battery capacity. It is necessary to read the user manual carefully and pay more attention to warning messages.
 2. Batteries of the same model and specification as manufacture configuration should be used.
 3. **DANGER OF EXPLOSION** -- Do not reverse the anode and the cathode when installing the battery.
 4. Do not heat or splash the battery or throw it into fire or water.
 5. Do not destroy the battery; do not pierce battery with a sharp object such as a needle; do not hit with a hammer, step on or throw or drop to cause strong shock; do not disassemble or modify the battery.
 6. When leakage or foul smell is found, stop using the battery immediately. If your skin or cloth comes into contact with the leakage liquid, cleanse it with clean water at once. If the leakage liquid splashes into your eyes, do not wipe them. Irrigate them with clean water first and go to see a doctor immediately.
 7. Properly dispose of or recycle the depleted battery according to local regulations.
 8. Remove the battery from the transmitter if the system won't be used for a long time.
-
-

1.2.3 General Cautions

CAUTION

1. Avoid liquid splash and excessive temperature. The temperature must be kept between 5 °C and 40 °C during operation, and it should be kept between -20 °C and 55 °C during transportation and storage.
 2. Do not use the equipment in a dusty environment with bad ventilation or in the presence of corrosive.
 3. Make sure that there is no intense electromagnetic interference source around the equipment, such as radio transmitters or mobile phones etc. Attention: large medical electrical equipment such as electrosurgical equipment, radiological equipment and magnetic resonance imaging equipment etc. is likely to bring electromagnetic interference.
 4. Ruptured fuse must only be replaced with that of the same type and rating as the original.
 5. The device and accessories are to be disposed of according to local regulations after their useful lives. Alternatively, they can be returned to the dealer or the manufacturer for recycling or proper disposal. Batteries are hazardous waste. Do NOT dispose of them together with house-hold garbage. At the end of their lives hand the batteries over to the applicable collection points for the recycling of waste batteries. For more detailed information about recycling of this product or battery, please contact your local Civic Office, or the shop where you purchased the product.
 6. Federal (U.S.) law restricts this device to sale by or on the order of a physician.
-
-

1.2.4 Operation for Wireless System

WARNING

1. Make sure that there is no intense electromagnetic interference source around the wireless system.
 2. Do not open the battery cover of the transmitter during operation.
-
-

1.2.5 Preparation and Operation Warnings (for Exercise ECG)

WARNING

1. Test the safety stop (mushroom type) and safety stop (cord type) of the treadmill before using the system.
 2. During the exercise test, ensure that there are at least 2 experienced physicians present. One of them observes the patient and deals with the emergency.
 3. Make sure that there is necessary valid first-aid equipment such as defibrillators, blood-pressure meters etc, and necessary valid medication in the exercise test room.
 4. Turn off the system power and disconnect the power cord from the wall outlet after using the system.
 5. Make sure that the power is turned off and the power cord is disconnected from the AC socket before defibrillation.
 6. Keep the four feet of the machine on the ground and make sure that it's stably working.
 7. The treadmill must be powered by the specific power outlet.
 8. Examine the treadmill/ergometer carefully before using it.
 9. The patient undergoing the exercise test should wear suitable clothes and shoes.
 10. Keep hands, hair, jewelry, and loose clothing away from moving parts.
 11. Don't let the patient stand on the running belt when starting the treadmill. The patient should stand on the foot rails and hold the handrails during start-up. Wait until the running belt is moving before placing feet on the belt.
 12. To avoid the static electricity, the patient should not wear loose clothing or clothing (such as nylon) that easily produces static electricity.
 13. Stop exercising immediately when the patient feels uncomfortable or something abnormal in the operation.
 14. Press down the safety stop (mushroom type) or pull out the safety stop (cord type) to stop the treadmill immediately when an emergency happens.
-
-

1.2.6 Contraindications (for Exercise ECG)











Absolute Contraindications:





1. Acute MI (within 2 days)
2. High-risk unstable angina
3. Hemodynamic compromise caused by uncontrolled cardiac arrhythmia
4. Symptomatic severe aortic stenosis
5. Heart failure with clinic episode uncontrolled
6. Acute pulmonary embolus or pulmonary infarction
7. Acute myocarditis or pericarditis
8. The patient opposes the test.

Relative Contraindications:

1. Left main coronary stenosis
2. Moderate stenotic valvular heart disease
3. Serum Electrolyte abnormalities
4. Severe hypertension (systolic blood pressure >200 mmHg or diastolic blood pressure >110 mmHg)
5. Tachyarrhythmias or bradyarrhythmias
6. Hypertrophic cardiomyopathy
7. Patients can not cooperate because of mental impairment or physical disability
8. High-degree AV block

1.3 List of Symbols

	Equipment or part of CF type with defibrillator proof
	Caution
	Consult Instructions for Use
	Recycle
P/N	Part Number
	Serial Number
	Date of Manufacture
	Manufacturer
	Authorized Representative in the European Community
	The symbol indicates that the device complies with the European Council Directive 93/42/EEC concerning medical devices.
	It indicates that the device should be sent to the special agencies according to local regulations for separate collection after its useful life.
Rx only (U.S.)	Federal (US) law restricts this device to sale by or on the order of a physician

	Class II
	Transmission Status Indicator of Bluetooth
	Burglar Lock
	Power Supply Indicator of DX12 Receiver

Chapter 2 Introduction

SE-1010 PC ECG has similar functions with an ordinary electrocardiograph. ECG data can be sampled, analyzed and stored in a PC, and it can be saved in PDF, Word, BMP or JPG format. ECG waves can be frozen and reviewed. Auto measurement and diagnosis are available, and the diagnosis template can be edited. SE-1010 PC ECG can also be invoked by Smart ECG Net version 1.3 or above.

When a patient with coronary heart disease runs, the added heart load will cause myocardium hypotension, and then the ECG will change abnormally. Therefore, with the function of exercise ECG, SE-1010 PC ECG can also be used to diagnose concealed coronary heart disease and atypical angina pectoris, prescribe the workload for patients with myocardial infarction before they leave hospital, and assess the effect of the treatment. With SE-1010 PC ECG, doctors' workload can be reduced greatly.

NOTE:

1. The exercise ECG function is optional. It is available only if you purchased this function.
2. The pictures and windows in this manual are for reference only.

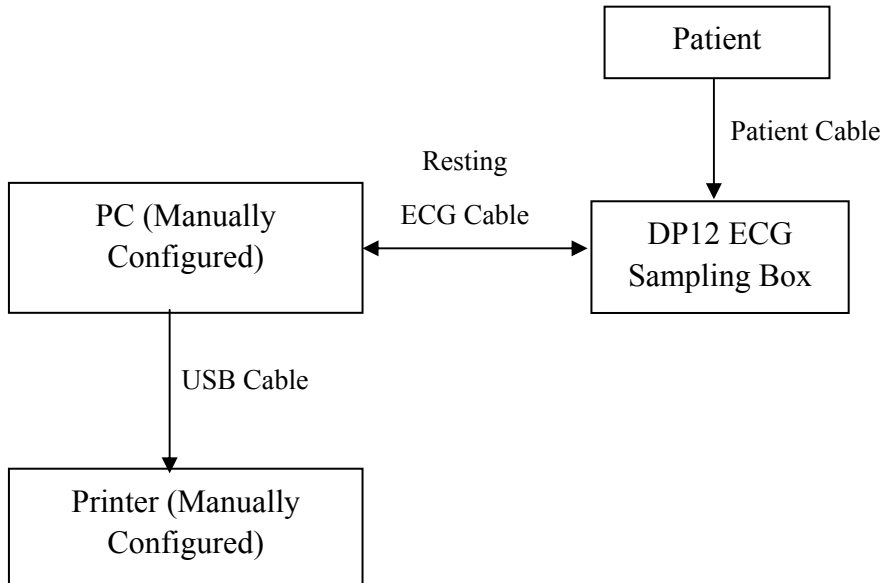
2.1 SE-1010 PC ECG System

SE-1010 PC ECG system includes the following equipment:

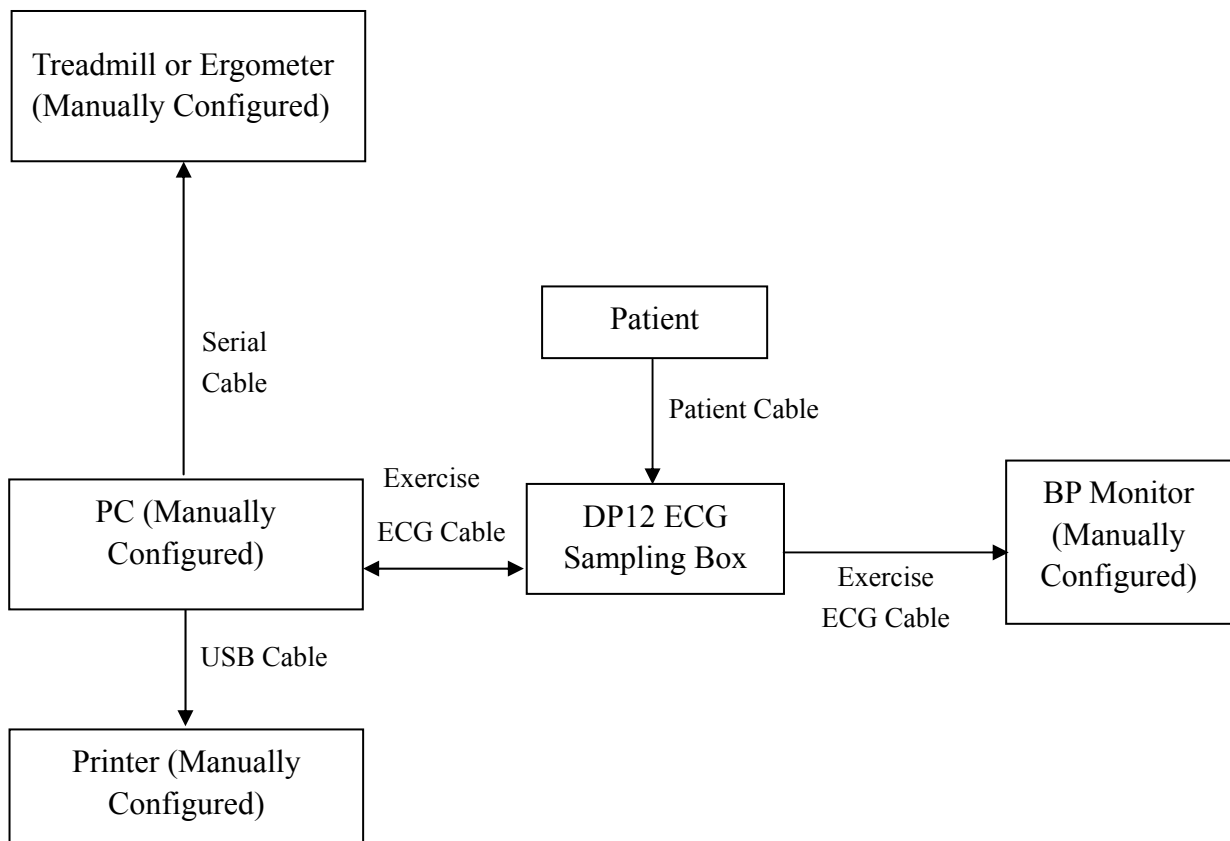
- PC ECG software
- ECG Sampling Box (wired or wireless system)
- Patient Cable
- Electrodes
- Sentinel
- USB Cable

Wired System of SE-1010 PC ECG System

1 Resting ECG of Wired System

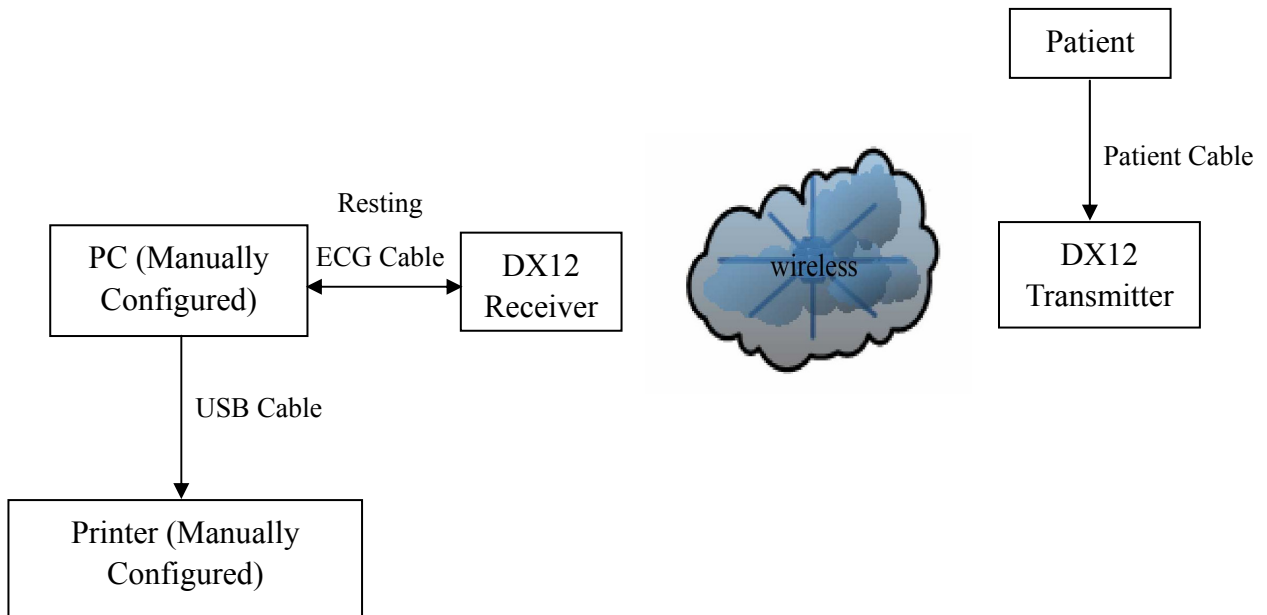


2 Exercise ECG of Wired System

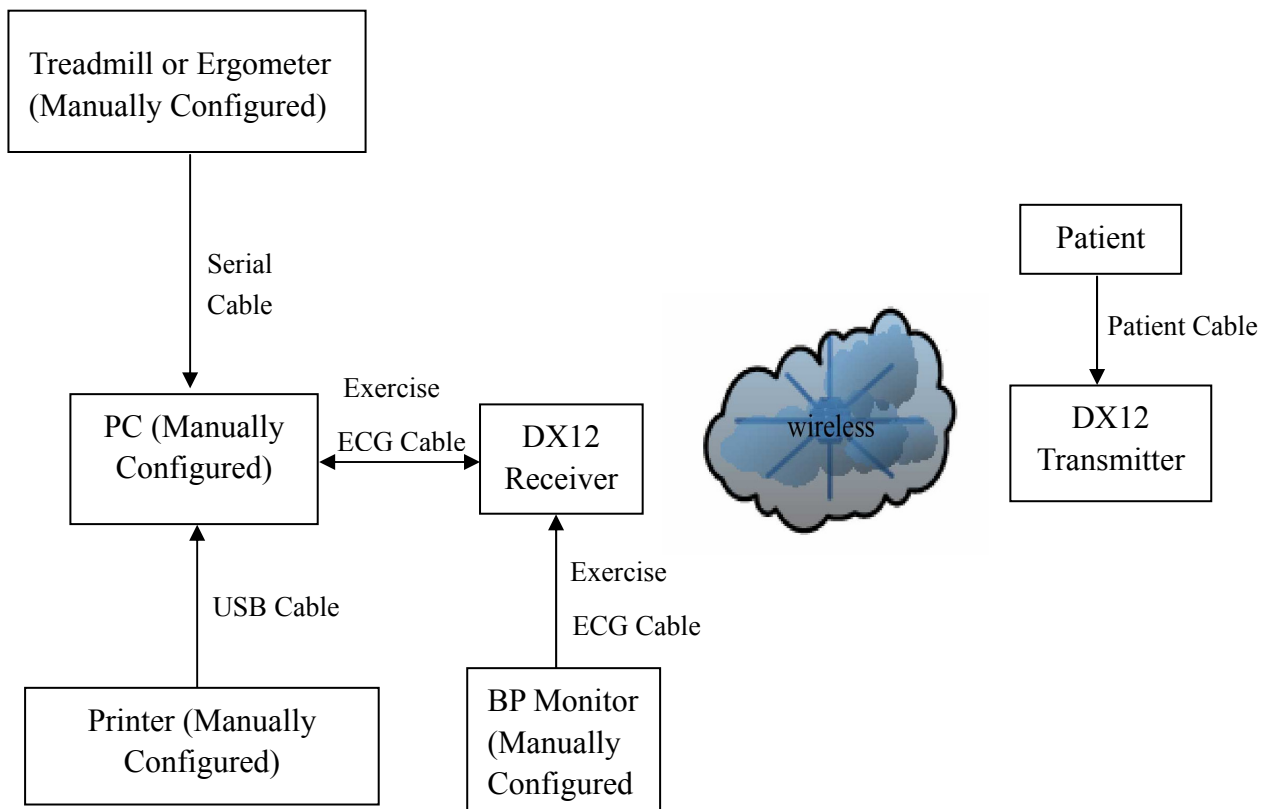


Wireless System of SE-1010 PC ECG System

1 Resting ECG of Wireless System



2 Exercises ECG of Wireless System

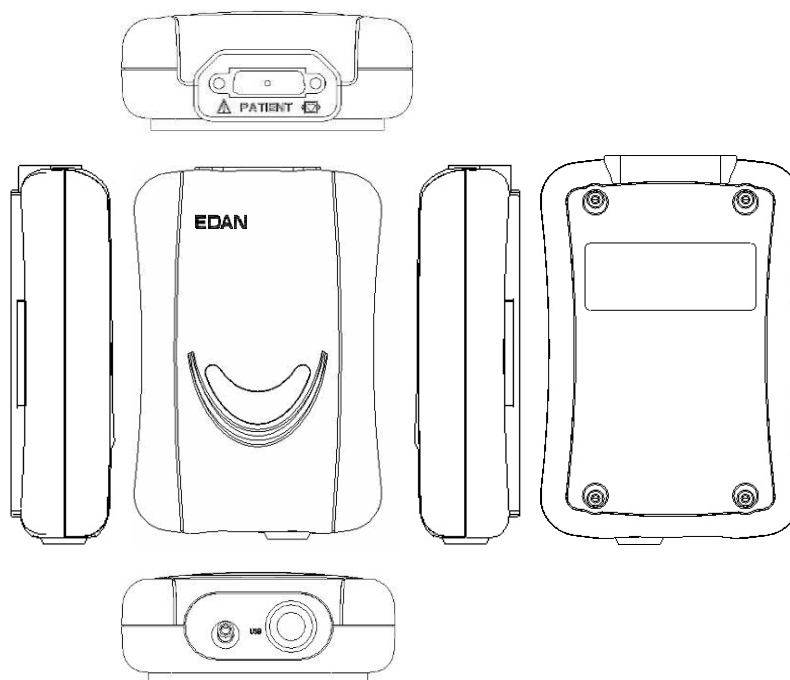


WARNING

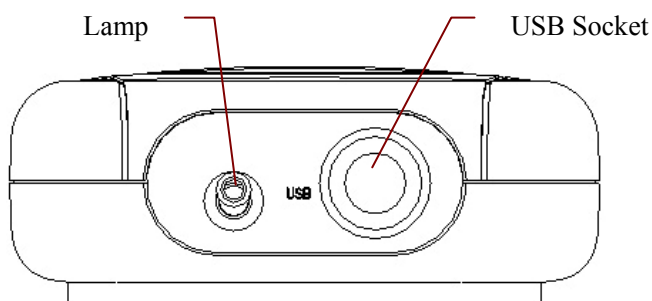
The system should be installed by a qualified service engineer. Do not power on the system until all cables are properly connected and verified.

2.2 DP12 ECG Sampling Box of Wired System

DP12 ECG Sampling Box Appearance

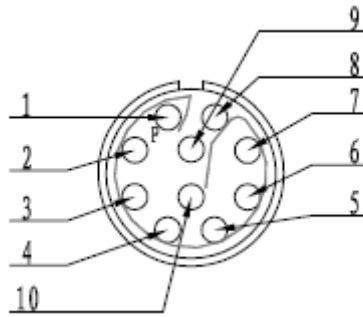


Front Panel



Name	Explanation
Lamp	When the ECG sampling box is powered by the PC, the lamp will be lit.
USB Socket	Connecting to the USB socket of the PC with a USB cable

USB Socket



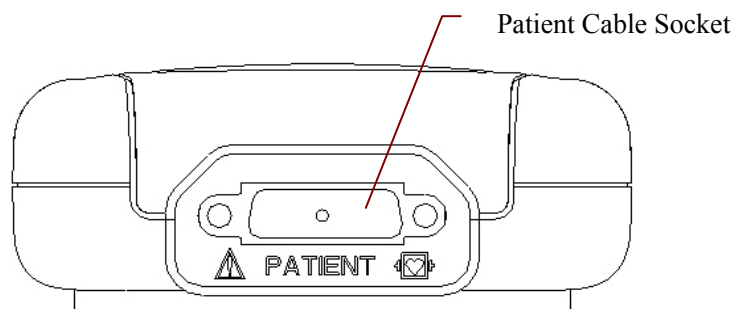
Definitions of corresponding pins:

Pin	Signal	Pin	Signal
1	GND	6	GND
2	VCC	7	GND
3	QRS	8	GND
4	GND	9	D-
5	GND	10	D+


WARNING

1. When the computer connected to the USB cable is powered on, do not connect the USB cable to the DP12 ECG sampling box; when the system is powered on, do not disconnect the USB cable from the ECG sampling box.
2. It is not necessary or recommended to regularly disconnect the USB cable from the DP12 ECG sampling box. Disconnect the USB cable from the PC if necessary.

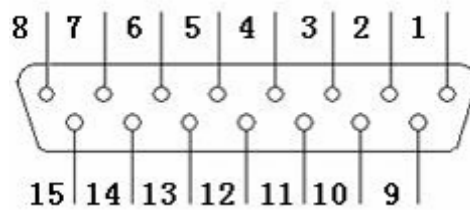
Back Panel



: Applied part of type CF with defibrillator proof

: Caution

Patient Cable Socket

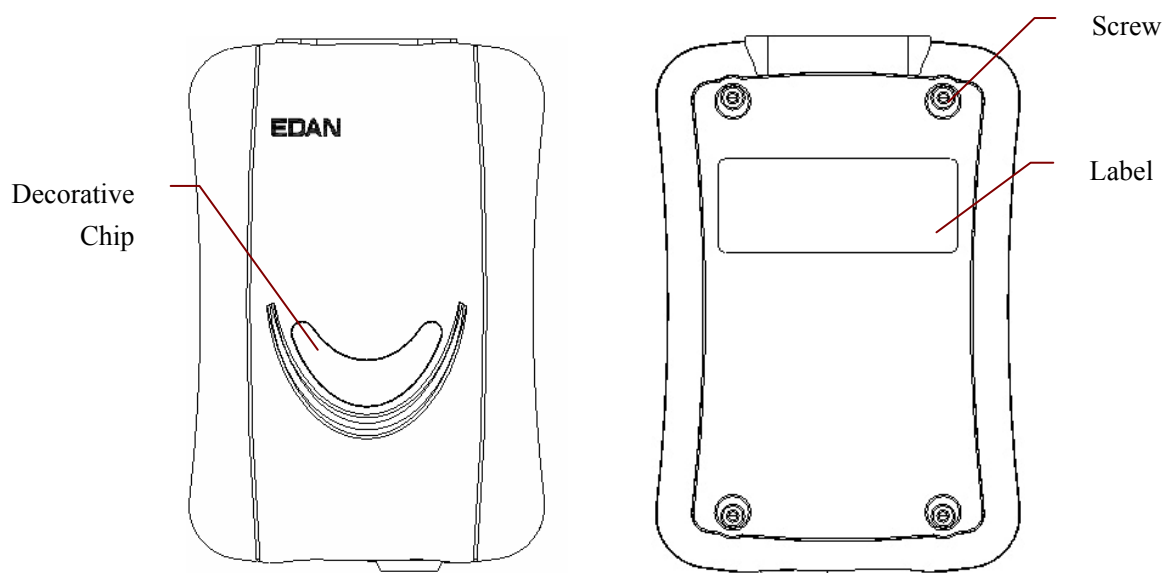


Definitions of corresponding pins:

Pin	Signal	Pin	Signal	Pin	Signal
1	C2 / V2	6	SH	11	F / LL
2	C3 / V3	7	NC	12	C1 / V1 or NC
3	C4 / V4	8	NC	13	C1 / V1
4	C5 / V5	9	R / RA	14	RF (N) / RL or NC
5	C6 / V6	10	L / LA	15	RF (N) / RL

NOTE: The left side of “/” is European standard, and the right side is American standard.

Top Panel and Bottom Panel

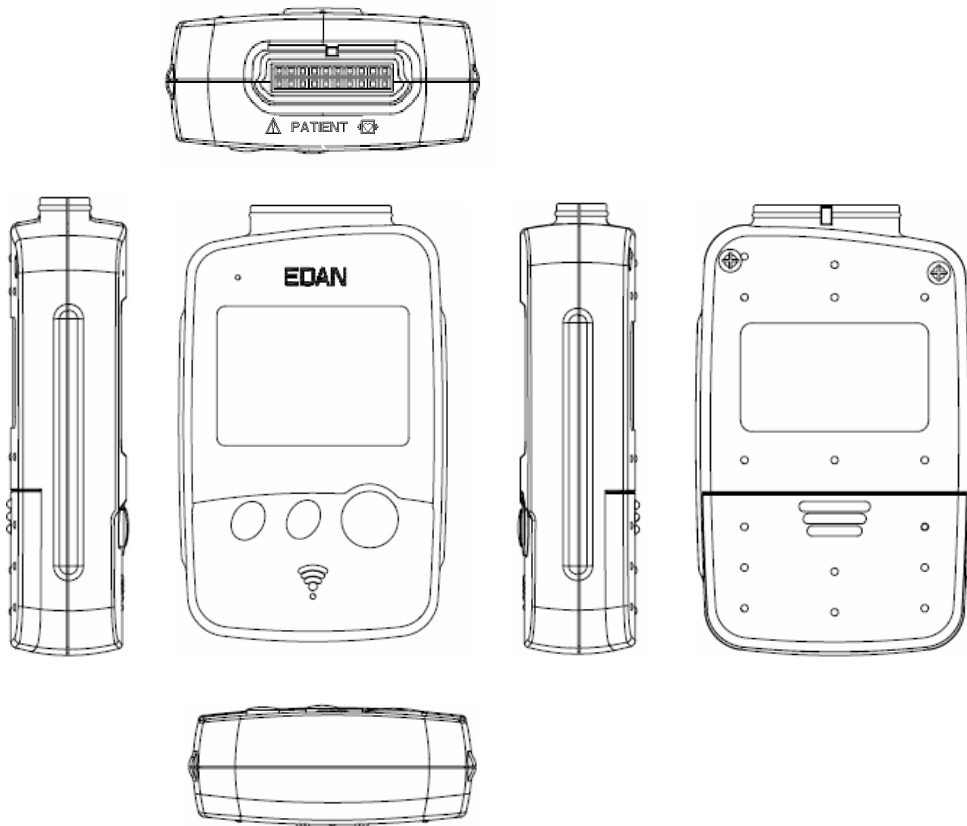


WARNING

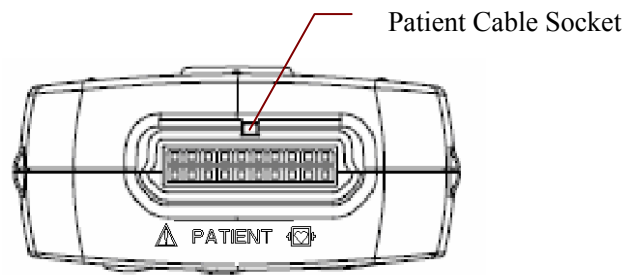
1. Accessory equipment connected to the analog and digital interfaces must be certified according to the respective IEC/EN standards (e.g. IEC/EN 60950 for data processing equipment and IEC/EN 60601-1 for medical equipment). Furthermore all configuration shall comply with the valid version of the standard IEC/EN 60601-1-1. Therefore anybody, who connects additional equipment to the signal input or output connector to configure a medical system, must make sure that it complies with the requirements of the valid version of the system standard IEC/EN 60601-1-1. If in doubt, consult our technical service department or your local distributor.
 2. If multiple instruments are connected to a patient, the sum of the leakage currents may exceed the limits given in the IEC/EN 60601-1 and may pose a safety hazard. Consult your service personnel.
-

2.3 DX12 ECG Sampling Boxes of Wireless System

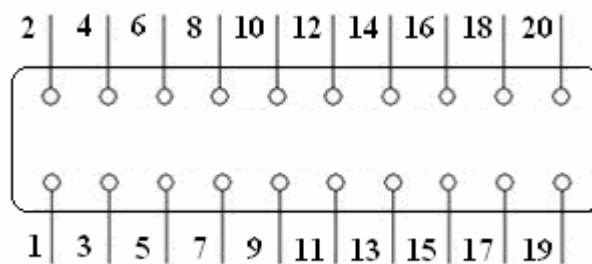
DX12 Transmitter Appearance




Front Panel



Patient Cable Socket



: Applied part of type CF with defibrillator proof

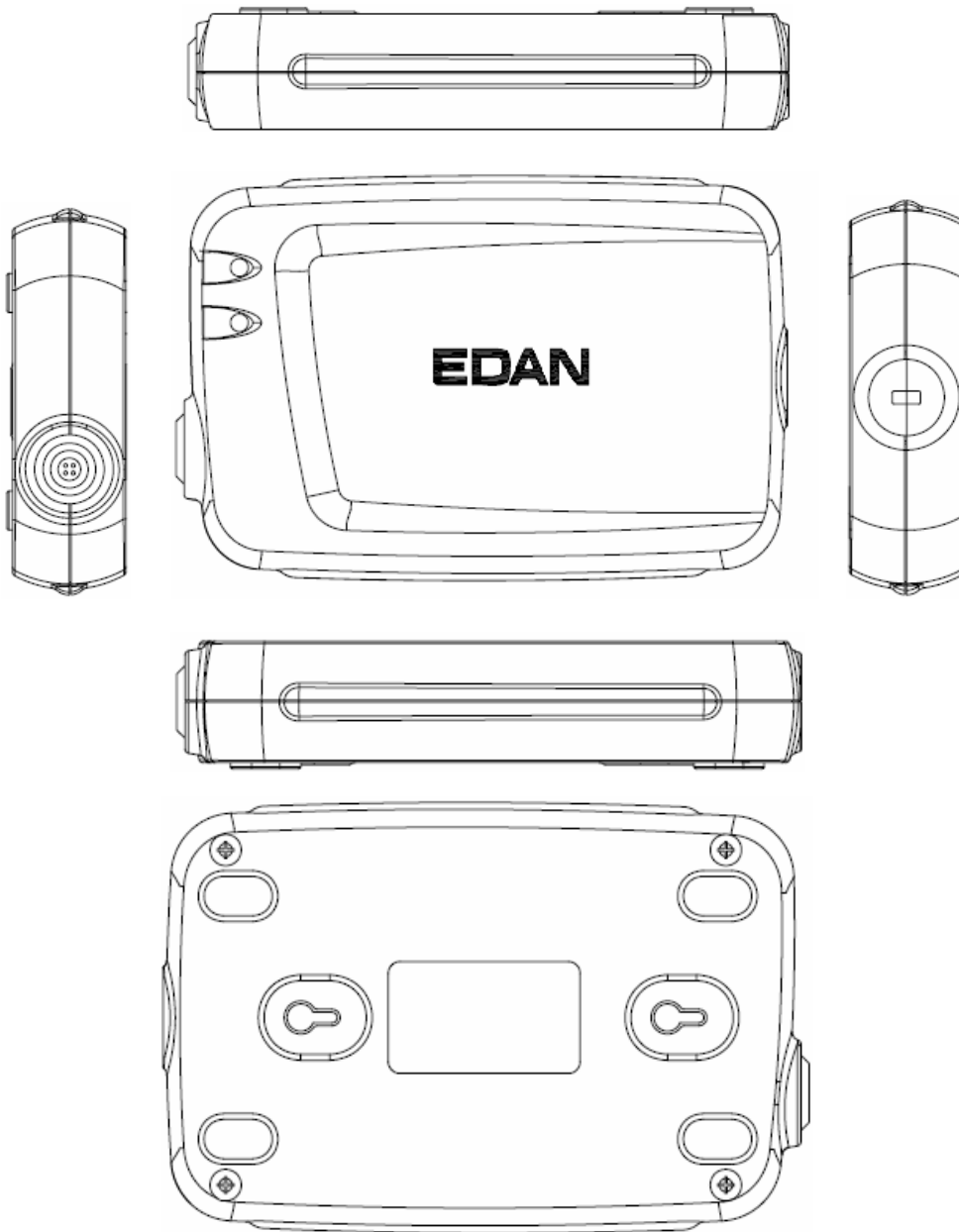
: Caution

Definitions of corresponding pins:

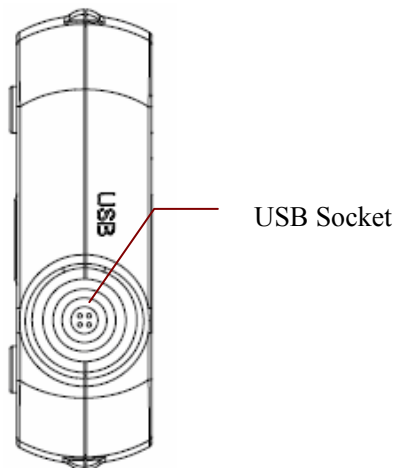
Pin	Signal	Pin	Signal	Pin	Signal	Pin	Signal
1	NC	6	C5/V5	11	NC	16	L/LA
2	F/LL	7	NC	12	C2/V2	17	NC
3	NC	8	C4/V4	13	NC	18	R/RA
4	C6/V6	9	NC	14	C1/V1	19	NC
5	NC	10	C3/V3	15	NC	20	N/RL

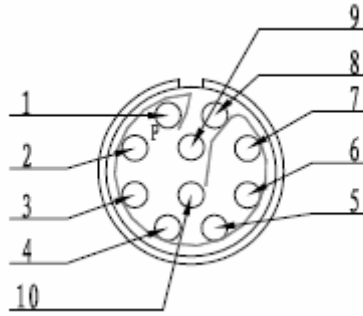
NOTE: The left side of “/” is European standard, and the right side is American standard.

DX12 Receiver Appearance



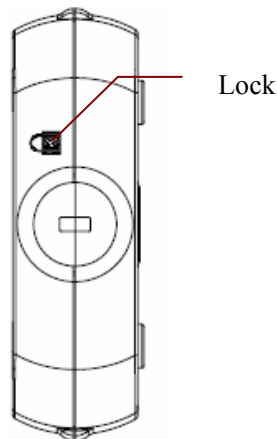
USB Socket





Definitions of corresponding pins:

Pin	Signal	Pin	Signal
1	GND	5	GND
2	VCC	6	GND
3	QRS	7	GND
4	GND	8	D-
5	GND	10	D+



2.4 Features

- ◆ Powerful functions, friendly windows and easy operation
- ◆ 3/6/12-channel ECG waves are displayed and printed simultaneously
- ◆ ECG waves can be frozen and reviewed
- ◆ Supporting auto measurement and diagnosis
- ◆ Measurement point adjustment and re-analysis, manual measurement with an electronic ruler of high precision
- ◆ Perfect data management and processing functions

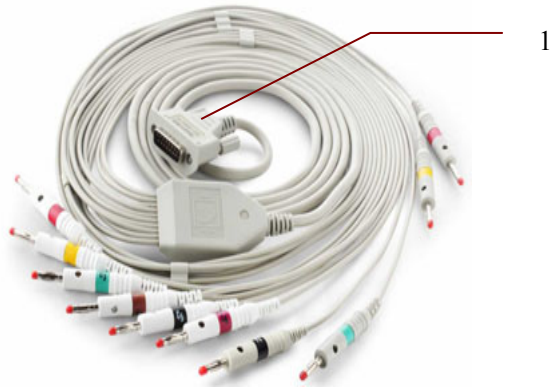
- ◆ Reports can be printed in PDF, Word, JPG or BMP format
- ◆ Supporting multi-language
- ◆ Updated to be a network electrocardiograph, transmitting ECG data over LAN or WAN or INTERNET
- ◆ Automatic baseline adjustment for optimal printing
- ◆ High performance filters guarantee stable ECG waveforms
- ◆ Real-time analysis, real-time displaying and printing 12-lead simultaneous ECG waveforms
- ◆ Nine analysis functions including Normal ECG, Frequency ECG, High Frequency ECG, QT Dispersion, Vector ECG, Time Vector ECG, HRT analysis, HRV analysis and Signal Averaged ECG (Only for resting ECG)

The following features are only for the exercise test function of SE-1010 PC ECG

- ◆ Automatically controlling and adjusting the speed and the elevation of the treadmill
- ◆ Supporting many kinds of treadmills and ergometers
- ◆ Providing classical exercise protocols; new exercise protocols can be added to the system
- ◆ ST segment analysis and measurement of 12-lead waveforms while sampling ECG; ST position is adjustable while sampling ECG
- ◆ Providing summaries, ST analysis, wave reviews and trends
- ◆ Providing specific statistic data of each lead in each stage
- ◆ Providing average waves of each lead in each stage for you to observe the changes of ST segments among different stages

Chapter 3 Assembling SE-1010 PC ECG System

3.1 Assembling Wired System



Patient Cable for Resting ECG



Patient Cable for Exercise ECG



DP12 ECG Sampling Box



Exercise ECG Cable



Resting ECG Cable



Assembly Drawing

For Resting ECG of wired system,

1. Insert plug 1 of the patient cable into socket 3 of DP12 ECG sampling box.
2. Insert plug 8 of the cable into socket 4 of DP12 ECG sampling box.
3. Insert plug 9 of the cable into the USB socket of the PC.
4. Connect a printer to the PC.
5. Insert the Sentinel into the USB socket of the PC.
6. Make sure that the above parts are properly connected, and then connect the PC, and the printer to the power supply.

For Exercise ECG of wired system,

1. Insert plug 2 of the patient cable into socket 3 of DP12 ECG sampling box.
2. Insert plug 7 of the cable into socket 4 of DP12 ECG sampling box.
3. Insert plug 5 of the cable into the USB socket of the PC.
4. Connect plug 6 of the cable to the BP monitor.
5. Connect a treadmill or an ergometer to the PC.
6. Connect a printer to the PC.
7. Insert the Sentinel into the USB socket of the PC.
8. Make sure that the above parts are properly connected, and then connect the PC, treadmill/ergometer and printer to the power supply.

WARNING

1. Use a special grounded socket to get accurate voltage and current.
 2. When using a laptop with a two-prong plug, please connect a grounded printer to avoid power interference.
 3. Only stress BP monitors can be used.
-

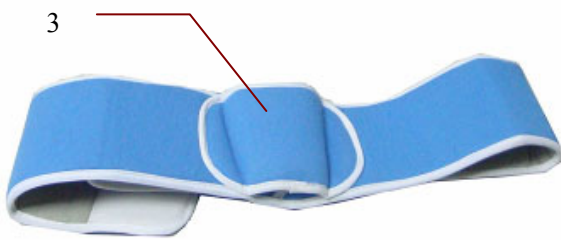
3.2 Assembling Wireless System



Patient Cable



DX12 Transmitter



DX12 Belt



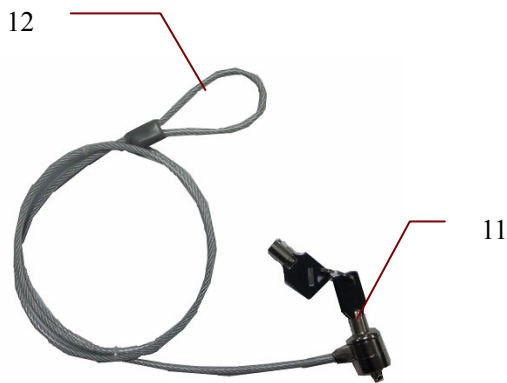
Resting ECG Cable



DX12 Receiver



Exercise ECG Cable



Burglar Lock



Assembly Drawing

For Resting ECG of wireless system,

1. Insert plug 1 of the patient cable into socket 2 of DX12 transmitter.
2. Insert plug 4 of the cable into socket 6 of DX12 receiver.
3. Insert plug 5 of the cable into the USB socket of the PC.
4. Connect a printer to the PC.
5. Insert the Sentinel into the USB socket of the PC.
6. Make sure that the above parts are properly connected, and then connect the PC, and the printer to the power supply.

For Exercise ECG of wireless system,

1. Insert plug 1 of the patient cable into socket 2 of DX12 transmitter.
2. Insert DX12 transmitter into pocket 3 of DX12 belt, and then wear the belt around the waist.
3. Insert plug 8 of the cable into socket 6 of the DX12 receiver.
4. Insert plug 9 of the cable into the USB socket of the PC.
5. Connect plug 10 of the cable to the BP monitor.
6. Connect a treadmill or an ergometer to the PC.
7. Connect a printer to the PC.
8. Insert the Sentinel into the USB socket of the PC.
9. Make sure that the above parts are properly connected, and then connect the PC, treadmill/ergometer and printer to the power supply.

WARNING

1. Use a special grounded socket to get accurate voltage and current.
2. When using a laptop with a two-prong plug, please connect a grounded printer to avoid power interference.
3. Only stress BP monitors can be used.

Chapter 4 Installing SE-1010 PC ECG Software

4.1 System Running Environment

4.1.1 Requirements on the Hardware of the PC

CPU:	Pentium P4, Celeron D 310 or above
System Memory (RAM):	512MB or above
Main Board	Recommend the main board of Intel chipset
Hard Disk:	40G or above
Printer:	ink jet printer of more than 600dpi or laser printer Recommend HP2035, HP2010、CANON iP1980
Display:	17" TFT (Resolution: 1024×768, 1280*1024, 1366*768) or 19" TFT (1440×900 resolution), 16 bit actual color, regular icon and font setup
Others:	CD-ROM (24 × or above)

4.1.2 Requirements on the Software of the PC

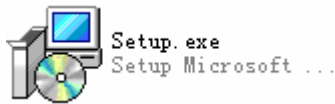
- ◆ Windows XP PROFESSIONAL SP2/SP3, Windows Vista (32/64 bit) or Windows 7 (32/64 bit)
- ◆ MSDE2000 (Microsoft SQL Server 2000 Desktop Engine) or Microsoft SQL Server 2005 Express

CAUTION

1. Ensure that there is no other database software in the PC in which our software will be installed.
2. Ensure that there is a graphic driver installed in the PC. Otherwise, the displayed ECG waves may be abnormal.

4.2 About Installation Window

Insert the installation CD into CD-ROM, and double-click on **Setup.exe**



to open the following installation window.



Figure 4-1 Installation Window

Click on the **Install** button to install PC ECG. Click on the **Next** button continually during installation.

After installing PC ECG, click on the **Install** button in the installation window. Then the **Environment Detection** window pops up. Check the installing status of all the components. If the **Environment Detection** window shows that a certain component needs to be installed, please install it manually.

NOTE: During the installation of SQL Server 2005 Express in Windows 7/Vista, only if **Add user to the SQL Server Administrator role** is selected, can the database be available.

Click on the **Help** button to see the installation guide.

For details on installing PC ECG software, please refer to *SE-1010 PC ECG Installation Guide*.

Chapter 5 Preparations Before Operation

5.1 Preparing the Patient

5.1.1 Instructing the Patient

Before attaching the electrodes, greet the patient and explain the procedure. Explaining the procedure decreases the patient's anxiety. Reassure the patient that the procedure is painless. Privacy is important for relaxation. When possible, prepare the patient in a quiet room or area where others can't see the patient. Make sure that the patient is comfortable. The more relaxed the patient is, the less the ECG will be affected by noise.

5.1.2 Preparing the Skin

Thorough skin preparation is very important. The skin is a poor conductor of electricity and frequently creates artifacts that distort the ECG signals. By performing methodical skin preparation, you can greatly reduce the possibility of noise caused by muscle tremor and baseline drift, ensuring high-quality ECG waves. There is natural resistance on the skin surface due to dry, dead epidermal cells, oils and dirt.

To prepare the skin

1. Shave hair from electrode sites, if necessary. Excessive hair prevents a good connection.
2. Wash the area thoroughly with soap and water.
3. Dry the skin to increase capillary blood flow and to remove the dead, dry skin cells and oils.
4. Use the disposable frosting film in the standard accessory list to get good ECG waveform.

NOTE: Rub the skin with a gauze pad to increase capillary blood flow if you don't operate the steps above.

5.2 Connecting the Electrodes of Wired System

WARNING

The performance and electric shock protection can be guaranteed only if the original patient cable and electrodes of the manufacturer are used.

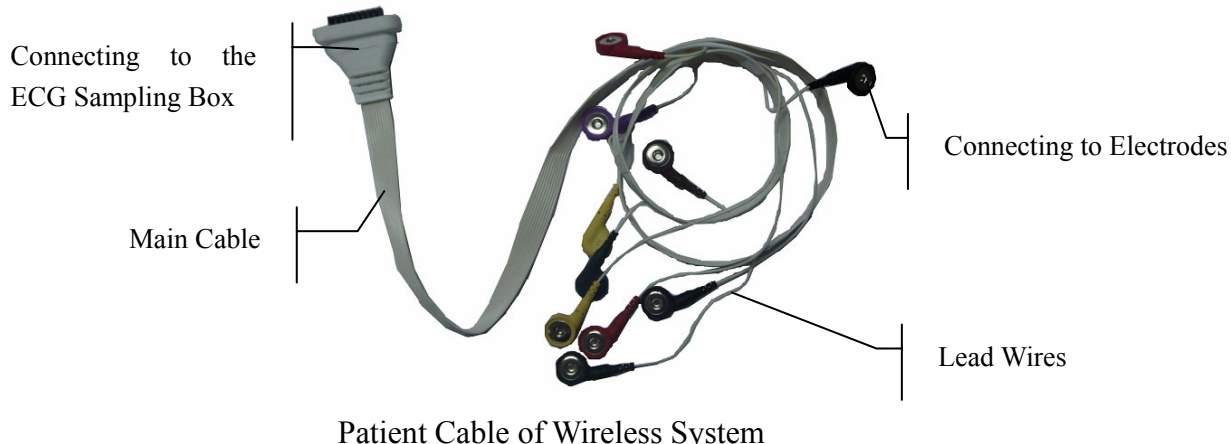
The patient cable includes main cable and lead wires which can be connected to electrodes according to the colors and identifiers.



1. Connect the patient cable to DP12 ECG sampling box of wired system. For details, please refer to Section 3.1, "Assembling Wired System".
2. Align all lead wires of the patient cable to avoid twisting, and connect the lead wires to the corresponding electrodes according to the colors and identifiers. Firmly attach them.

5.3 Connecting the Electrodes of Wireless System

The patient cable includes main cable and lead wires which can be connected to electrodes according to the colors and identifiers.



1. Connect the patient cable to DX12 transmitter of wireless system. For details, see Section 3.2, “Assembling Wireless System”.
2. Align all lead wires of the patient cable to avoid twisting, and connect the lead wires to the corresponding electrodes according to the colors and identifiers. Firmly attach them.

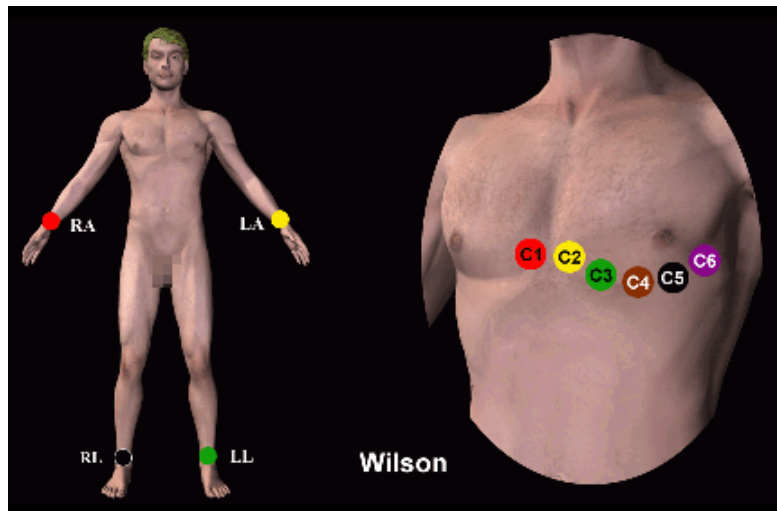
5.4 Attaching Electrodes (for Resting ECG)

The identifiers and color codes of electrodes used comply with IEC/EN requirements. In order to avoid incorrect connections, the electrode identifiers and color codes are specified in Table 5-1. Moreover the equivalent codes according to American requirements are given in Table 5-1 too.

Table 5-1 Electrodes and Their Identifiers and Color Codes

		European		American	
WILSON	FRANK	Identifier	Color Code	Identifier	Color Code
Right arm	Right arm	R	Red	RA	White
Left arm	Left arm	L	Yellow	LA	Black
Right leg	Right leg	N or RF	Black	RL	Green
Left leg	Left leg	F	Green	LL	Red
Chest 1	I	C1	White/Red	V1	Brown/Red
Chest 2	E	C2	White/Yellow	V2	Brown/Yellow
Chest 3	C	C3	White/Green	V3	Brown/Green
Chest 4	A	C4	White/Brown	V4	Brown/Blue
Chest 5	M	C5	White/Black	V5	Brown/Orange
Chest 6	H	C6	White/Violet	V6	Brown/Violet

5.4.1 Wilson Lead System



C1: Fourth intercostal space at the right border of the sternum

C2: Fourth intercostal space at the left border of the sternum

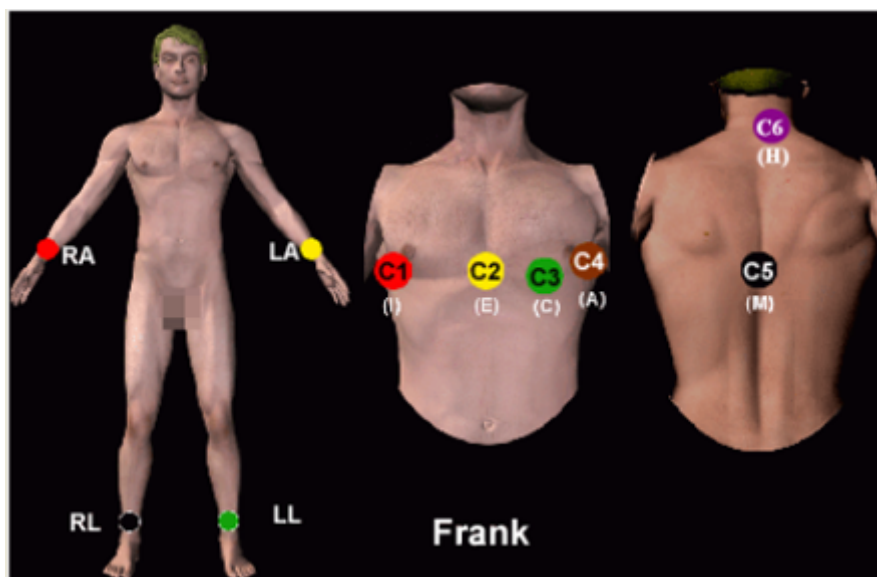
C3: Fifth rib between C2 and C4

C4: Fifth intercostal space on the left midclavicular line

C5: Left anterior axillary line at the horizontal level of C4

C6: Left midaxillary line at the horizontal level of C4

5.4.2 Frank Lead System



FRANK lead system is usually adopted when PC ECG is used to produce VCG. The conventional letter designations for the electrodes and their respective positions are:

E/C2: at the front midline

M/C5: at the back midline

I/C1: at the right mid-axillary line

A/C4: at the left mid-axillary line

C/C3: at 45° angle between the front midline and the left mid-axillary line

F: on the left leg

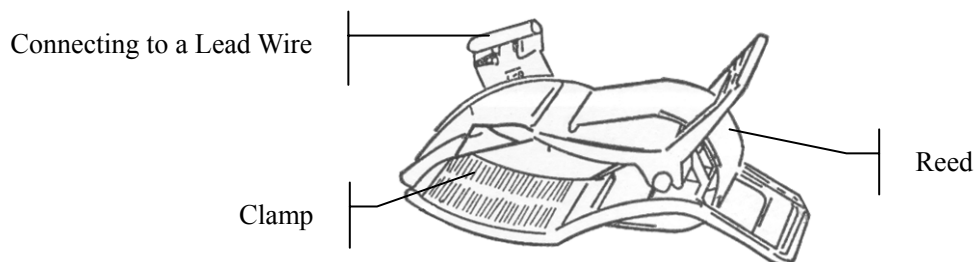
N: on the right leg

H: on the back of the neck

The first five electrodes (E, M, I, A and C) are all located at the same transverse level -- approximately at the interspace between the fourth rib and the fifth rib.

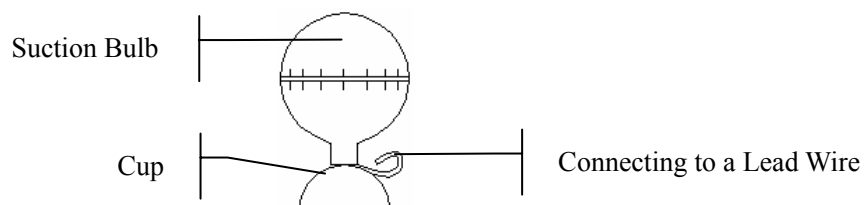
5.4.3 Attaching Electrodes to the Patient

For Limb Electrodes:



1. Clean the electrode area which is in a short distance above the ankle or the wrist with alcohol.
2. Daub the electrode area on the limb with gel evenly.
3. Place a small amount of gel on the metal part of the limb electrode clamp.
4. Connect the electrode to the limb, and make sure that the metal part is placed on the electrode area above the ankle or the wrist.
5. Attach all limb electrodes in the same way.

For Chest Electrodes:



1. Clean the electrode area on the chest surface with alcohol.
2. Daub the round area of 25mm in diameter on each electrode area with gel evenly.
3. Place a small amount of gel on the brim of the chest electrode's metal cup.
4. Place the electrode on the chest electrode area and squeeze the suction bulb. Unclench it and the electrode is adsorbed on the chest.
5. Attach all chest electrodes in the same way.

Chest Electrode (Only for C5 in Frank Lead System):**Snap/Banana Socket Adapter:****Disposable Electrode:****Disposable Electrode Connection:**

1. Connect the snap/banana socket adapter to the lead wire.
2. Connect the snap/banana socket adapter to the disposable electrode.
3. Clean the electrode area at the back midline with 75% alcohol.
4. Attach the disposable electrode to the electrode area at the back midline.

The quality of ECG waveform will be affected by the contact resistance between the patient and the electrode. In order to get a high-quality ECG, the skin-electrode resistance must be minimized while connecting electrodes.

WARNING

1. Make sure that all electrodes are connected to the patient correctly before operation.
 2. Make sure that the conductive parts of electrodes and associated connectors, including neutral electrodes, do not come in contact with earth or any other conducting objects.
 3. The disposable electrodes can only be used for one time.
-

5.5 Attaching Electrodes to the Patient (for Exercise ECG)

The identifiers and color codes of electrodes used comply with IEC/EN requirements. In order to avoid incorrect connections, the electrode identifiers and color codes are specified in Table 5-2. Moreover the equivalent codes according to American requirements are given in Table 5-2 too.

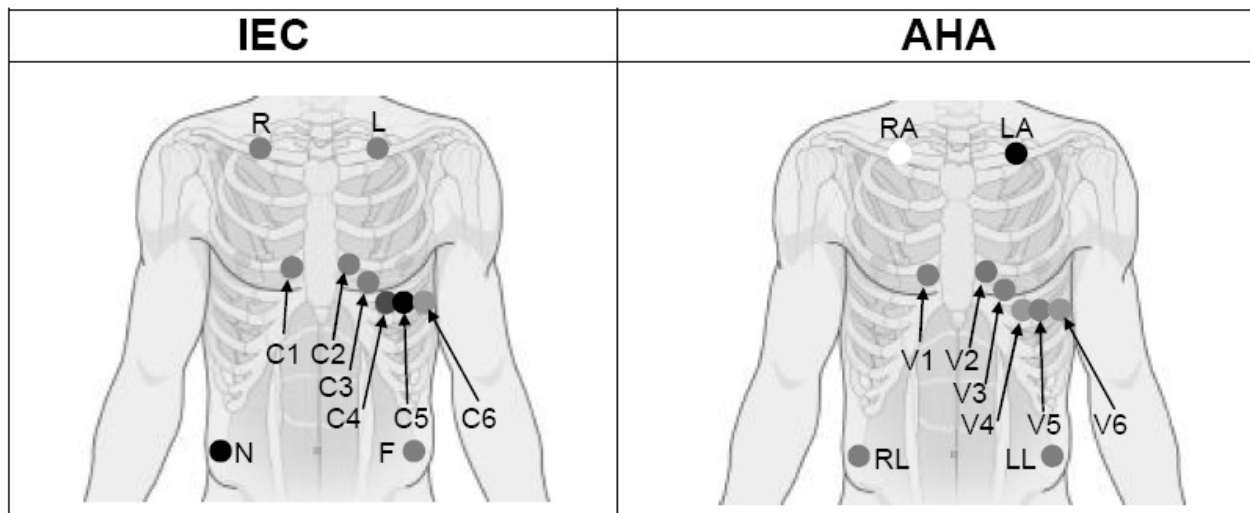


Table 5-2 Electrodes and their identifiers and color codes

European		American	
Electrodes	Color code	Electrodes	Color code
R	Red	RA	White
L	Yellow	LA	Black
N or RF	Black	RL	Green
F	Green	LL	Red
C1	White/Red	V1	Brown/Red
C2	White/Yellow	V2	Brown/Yellow
C3	White/Green	V3	Brown/Green
C4	White/Brown	V4	Brown/Blue
C5	White/Black	V5	Brown/Orange
C6	White/Violet	V6	Brown/Violet

The Precordial Electrodes' Positions on Body Surface:

C1: Fourth intercostal space at the right border of the sternum

C2: Fourth intercostal space at the left border of the sternum

C3: Fifth rib between C2 and C4

C4: Fifth intercostal space on the left midclavicular line

C5: Left anterior axillary line at the horizontal level of C4

C6: Left midaxillary line at the horizontal level of C4

The Extremity Electrodes' Positions on Body Surface:

R/L: below the right/left clavicle

N/F: below the right/left rib

The quality of ECG waveform will be affected by the contact resistance between the patient and the electrode. In order to get a high-quality ECG, the skin-electrode resistance must be minimized while connecting electrodes.

Electrodes Connection:

1. Align all lead wires of the patient cable to avoid twisting, and connect the disposable electrodes to the lead wires.
2. Clean the electrode areas on the body surface with 75% alcohol.
3. Attach the disposable electrodes to the electrode sites.

NOTE: The quality and the placement of the electrode will directly influence the quality of exercise ECG. The wrong placement and use of electrodes will cause incorrect analysis results.

WARNING

1. Make sure that all electrodes are connected to the patient correctly before operation.
 2. Make sure that the conductive parts of electrodes and associated connectors, including neutral electrodes, do not come in contact with earth or any other conducting objects.
 3. The disposable electrodes can only be used for one time.
-
-

5.6 Inspection Before Test

In order to avoid safety hazards and get good ECG records, the following inspection procedure is recommended before operation.

1. Environment:

- ◆ Make sure that there is no electromagnetic interference source around the equipment, especially large medical electrical equipment such as electrosurgical equipment, radiological equipment, magnetic resonance imaging equipment etc. Switch off these devices when necessary.
- ◆ Keep the examination room warm to avoid muscle action voltages in ECG signals caused by cold.

2. Power Supply:

- ◆ Check whether the power cord is connected well. The grounded outlet should be used.

3. Patient Cable:

- ◆ Check whether the patient cable is connected to the ECG sampling box firmly, and keep it far away from the power cord.

4. Electrodes:

- ◆ Check whether all electrodes are connected to lead wires of the patient cable correctly.
- ◆ Ensure that the electrodes do not contact.


5. Patient:

- ◆ The patient should not come into contact with conducting objects such as earth, metal parts etc.
- ◆ Ensure the patient is warm and relaxed, and breathes calmly.

WARNING

1. The system is intended to be used by qualified physicians or personnel professionally trained. They should be familiar with the contents of this user manual before operation.
 2. Before connecting the device to the power line, make sure that the voltage and frequency ratings of your power line match those indicated on the device label. For details, see Appendix 1, "Technical Specifications".
 3. Before use, the system, patient cable, electrodes etc. should be checked. Replacement should be taken if there is any evident defectiveness or aging symptom which may impair the safety or the performance.
-

5.7 Setting DX12 Transmitter (for Wireless System)

Switch on DX12 receiver and install batteries on DX12 transmitter. Press  to start up DX12 transmitter, and then the company information and the main screen will be displayed.

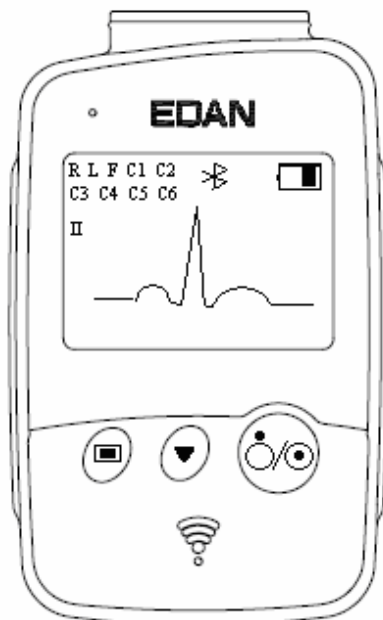
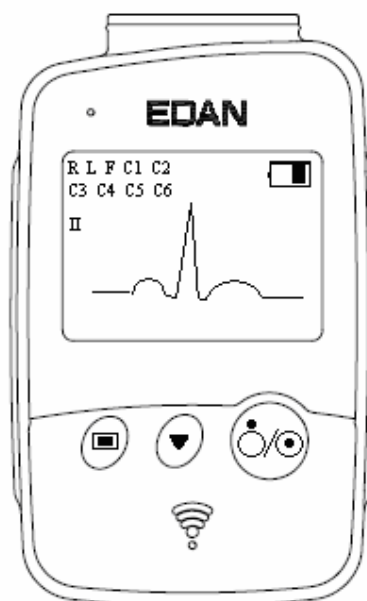


Figure 5-1 Main Screen

When the main screen is displayed, press  to switch the leads.

If the Bluetooth connection icon  is not displayed on the main screen, you have to match the device manually. Operation instructions are as follows:






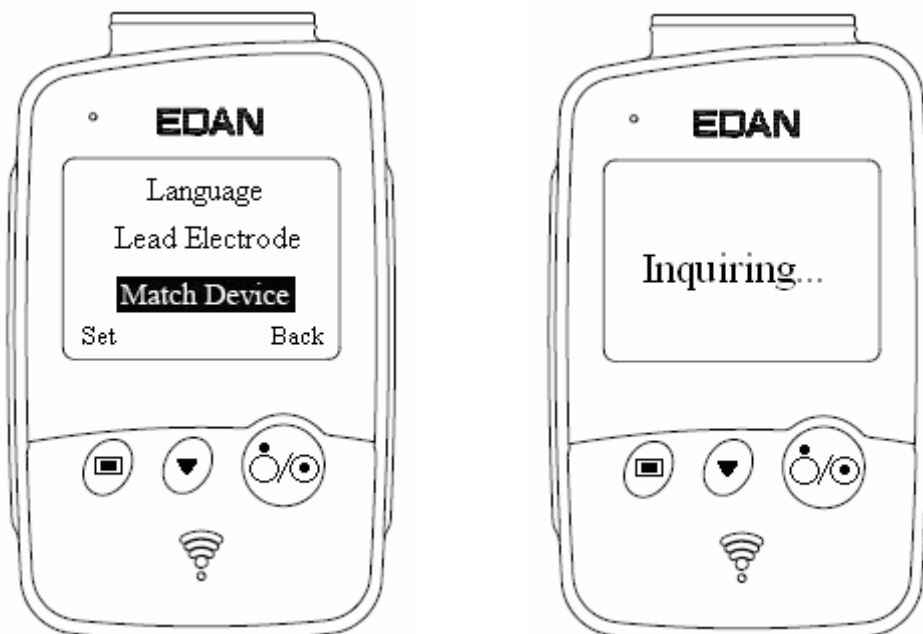


1. Press  to enter the menu screen.



Figure 5-2 Menu Screen

2. Press  to display **Match Device** item in black, and then press  to open the screen with a prompt “Inquiring...”.




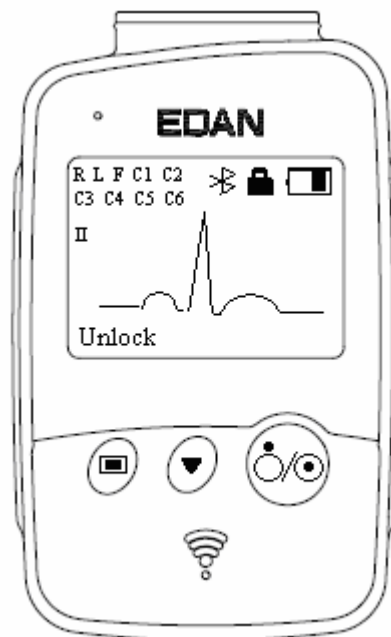
3. When the receiver is found, the address of DX12 receiver will be displayed on the screen in 10 seconds. Press  to start up the Bluetooth connection. The Bluetooth connection  will be displayed on the main screen of DX12 transmitter and the Bluetooth status indicator illuminates in kelly when DX12 transmitter and DX12 receiver are matched successfully. The Bluetooth status indicator blinks when a data transmission builds between DX12 transmitter and DX12 receiver. The system will return to the previous menu if no DX12 receiver is found.



NOTE: Select the receiver address displayed in the PC ECG software when receiving more than one addresses. For details, please refer to Section 9.3 “Device Setup”.



5.7.1 Keyboard Locking/Unlocking

If no operation is taken, the keyboard will be locked automatically in 8 seconds. If the previous screen is the menu screen, it will return to the main screen after the keyboard is locked automatically.

When the keyboard is locked, a prompt **unlock** will be displayed on the left bottom of the main screen and an icon  will be displayed on the top right.



When the keyboard is locked, press , and then press  in 1.2 seconds to unlock the keyboard.

When the keyboard is unlocked, press , and then press  in 1.2 seconds to lock the keyboard manually.

5.7.2 Menu Settings






Press  on the main screen to enter the menu screen (Figure 5-2). Press  on the menu screen to display an item in black, and then press  to enter the setting screen of this item.

Table 5-3 Menu

Menu	Option	Description
Back Light	On	Select On to turn on the backlight of LCD screen.
	Off	Select Off to turn off the backlight of LCD screen.
Auto Sleep	On	Select On to display Sleeping on the screen and make DX12 transmitter be in low power consumption mode after lead off for 5 minutes.
	Off	Select Off to turn off auto sleep function.
Language	English	You can select English or Chinese .
	Chinese	
Lead Electrode	IEC	You can select IEC or AHA .
	AHA	
Match Device	Inquiring..... Address of DX12 receiver No device found. Try again later.	Inquiring..... will be displayed (for 10 seconds) to search DX12 receiver. The address of DX12 receiver will be displayed (for 8 seconds) if a matching DX12 receiver is found. No device found. Try again later will be displayed (for 1 second) if no matching DX12 receiver is found.
Device Information	Software version: 1.0 ID: 0016a400035D EDAN 2010.04.20	You can see the related information, such as software version, ID, address of DX12 receiver, manufacture and release time about the device. NOTE: The device information is for reference only.

Chapter 6 Operation Instructions for Resting ECG

Double-click on the shortcut icon  on the desktop to display the main screen.  is the desktop icon for SE-1010 PC ECG.

NOTE: Do not use other software when using PC ECG software.

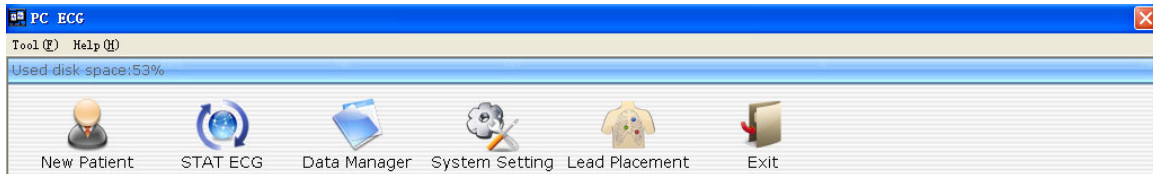


Figure 6-1 Toolbar of Main Screen

The toolbar contains six buttons. From left to right, they are **New Patient**, **STAT ECG**, **Data Manager**, **System Setting**, **Lead Placement** and **Exit**.

Below the toolbar, the software name, version number and copyright information can be seen.

Click on **Help (H)** to see the help information.

Click on the **Exit** button on the main screen to exit the system.

If you use PC ECG software for the first time, the following window will be displayed.

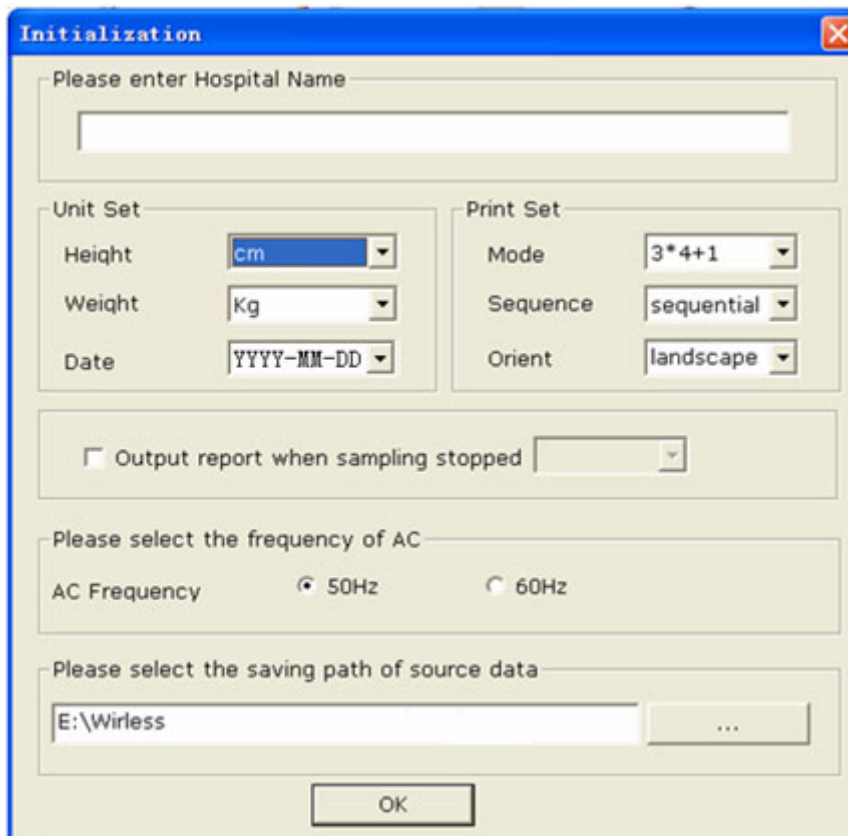


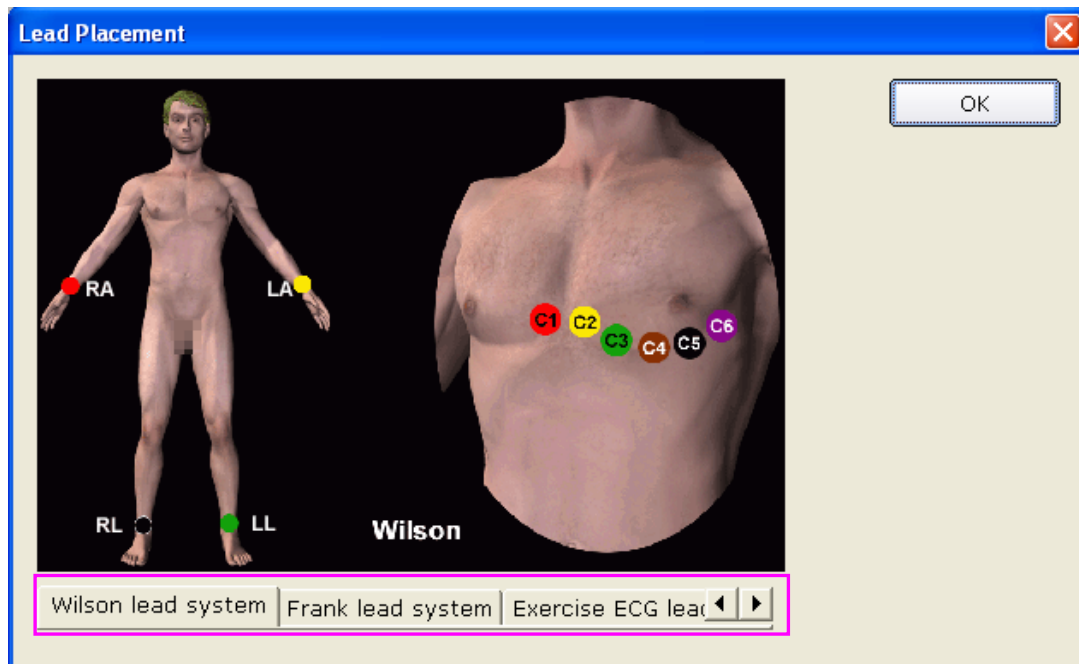
Figure 6-2 Initial Window

You can set the unit, print, frequency of AC and the saving path of source data based on your needs. Click on the **OK** button after setup, the system will enter the main screen automatically.

NOTE: You should install the software to the saving path of source data after the uninstallation and reinstallation; otherwise, the software needs a new configuration.

6.1 Viewing Lead Placement Information

1. Click on the **Lead Placement** button on the main screen to display the **Lead Placement** window.



2. Click on **Wilson lead system**, **Frank lead system** or **Exercise ECG lead system** to view the lead placement information in the corresponding system.

6.2 Selecting a Patient Record to Start a New Test

Click on the **Data Manager** button on the main screen (Figure 6-1) to open the **Data Manager** screen (Figure 6-3).

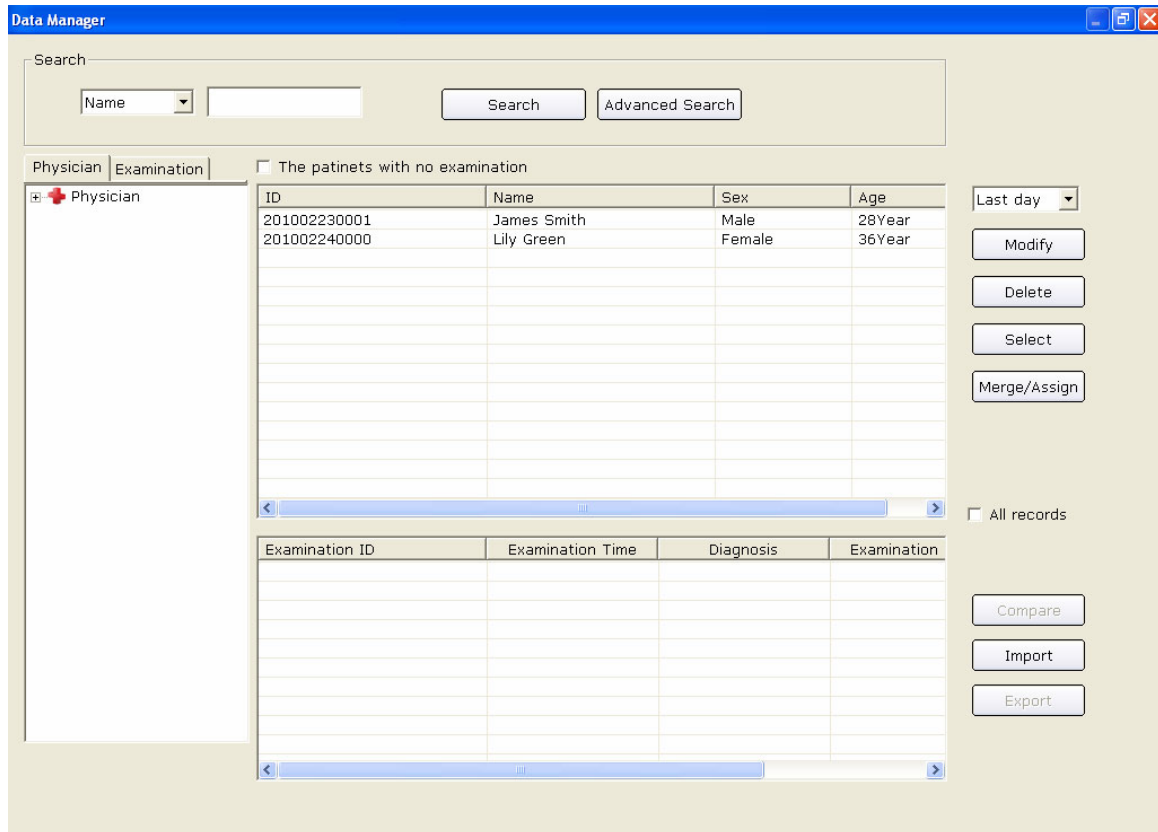
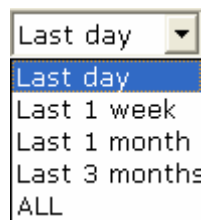
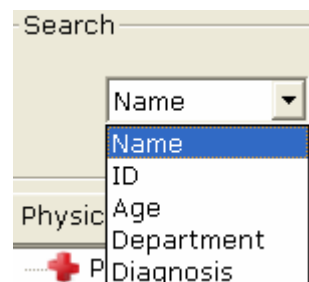


Figure 6-3 Data Manager Screen



1. Select a search item in the pull-down list **ALL** on the **Data Manager** screen. Then all the patient records which meet the search condition are listed in the patient information list.



2. Or, select a search item in the pull-down list **Physic**, enter the corresponding information in the right textbox, and then click on the **Search** button. All the patient records which meet the conditions will be displayed in the patient information list.

6.3 Entering New Patient Information

6.3.1 Entering New Patient Information Manually



If the patient is a new one, you can click on the **New Patient** button on the main screen (Figure 6-1) to display the **Patient Information** window.

Then you need to input the patient's related information.

1. Enter basic information, such as patient ID, name, sex and age.

User-defined 1 and User-defined 2: You can input other related information such as patients' medical records.

User-defined 1 and User-defined 2 can be set in the **Basic Information** window (Figure 9-1). Before setting them, the two items in the **Patient Information** window are unavailable. For details, please refer to Section 9.1.1, "Setting Basic Information".

NOTE: In the **Patient information** window, patient ID is a must. You can use the number generated by the system or input a number manually. Patient ID can be a random character string excluding '/', '\', ':', '*', '?', '<', '>' and '|'.

2. Enter additional information, such as BP, height, weight, medication and race.

NOTE: You can select the additional information items in the **Print Setting** window, and these additional information items will be displayed in the **Patient Information** window after setting printer.

For details, please refer to Section 9.4.1, "Choosing Patient Information to be Printed".

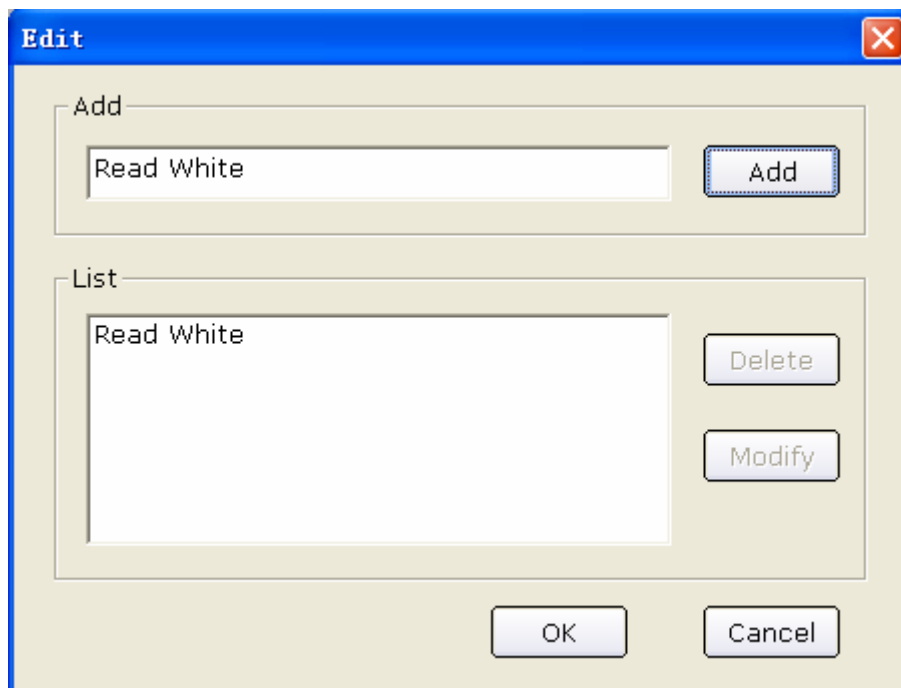
3. Enter information of doctor and department

1) Enter information of physician, technician or Req. physician



Click on the pull-down list **Edit...**, and then click on the **Edit** button to display the **Edit** window.

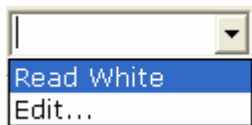
Enter the doctor name in the textbox, and then click on the **Add** button. The doctor name will be displayed in **List**. Meanwhile, you can also directly enter the doctor name in textbox of **Physician** item, and then click on the **OK** button in the **Patient Information** window.



Click on one name in **List**, and then you can delete or modify the name:

- ◆ Click on the **Delete** button, and then click the **OK** button to delete the name from the list.
- ◆ Click on the **Modify** button, enter a new name in textbox to modify the name, and then click on the **OK** button.

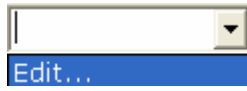
Click on the **OK** button to confirm and exit the **Edit** window, and then click on the



pull-down list, you can select the doctor name you enter.

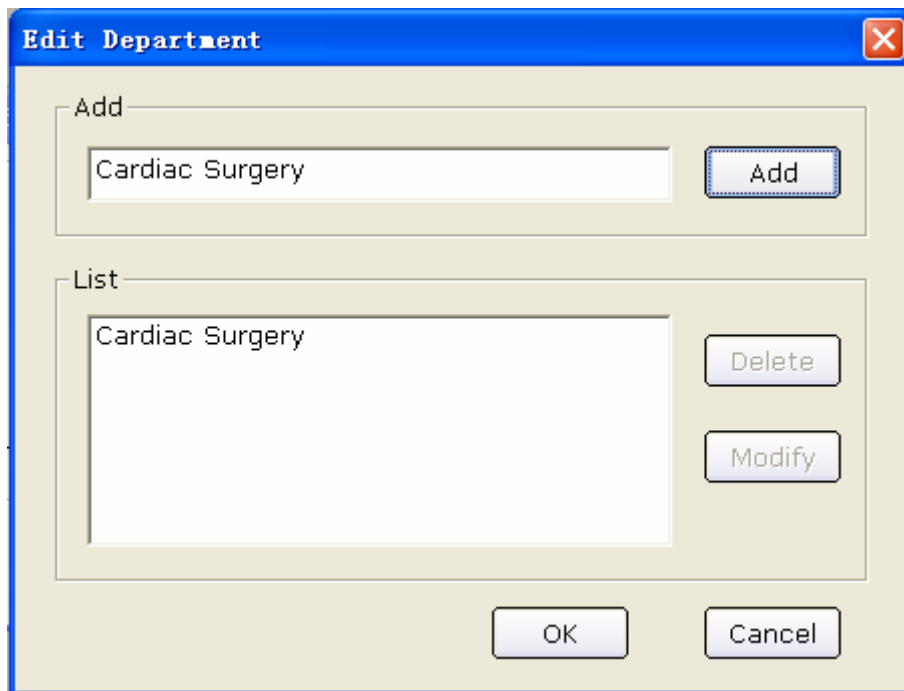
NOTE: Take the same steps above for entering information of technician or Req.physician.

2) Enter information of department



Click on the pull-down list **Edit...**, and then click on the **Edit** button to display the **Edit Department** window.

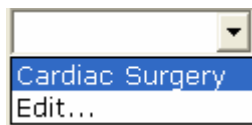
Enter the department name in the textbox, and then click on the **Add** button. The doctor name will be displayed in **List**. Meanwhile, you can also enter the department name in the textbox of **Dept.** item, and then click on the **OK** button in the **Patient Information** window.



Click on one department name in **List**, and then you can delete or modify the name:

- ◆ Click on the **Delete** button, and then click the **OK** button to delete the department name from the list.
- ◆ Click on the **Modify** button, enter a new name in the textbox to modify the department name, and then click on the **OK** button.

Click on the **OK** button to confirm and exit the **Edit** window, and then click on the



pull-down list **Edit...**, you can select the doctor name you enter.

NOTE: You can select **Physician**, **Technician** or **Req.physician** in the **Print Setting** window. Before setting them, these items in the **Patient Information** window are unavailable. For details, please refer to Section 9.4.1, "Choosing Patient Information to be Printed".

4. Confirm pacemaker information

If you select **Pacemaker** in the **Print Setting** window, **Pacemaker** appears in the **Patient Information** window. Select **Pacemaker** to detect very small pacemaker pulses. However, when pacemaker pulse enhancer is on, the system is very sensitive, and should not be close to equipment emitting high frequency radiation. High frequency radiation can interfere with pacemaker pulse detection and normal ECG acquisition.

NOTE: Pacemaker is recommended to be deselected unless it is known that the majority of the electrocardiograph usage will be on patients with pacemakers.

5. Select risk indicators and symptoms (for Exercise ECG), such as cigarette, diabetes, congenital heart disease, hypertension, hyperlipemia and family medical history.

NOTE: You can select risk indicators and symptoms only in Exercise ECG mode.

6.3.2 Entering Patient Information by Using a Bar Code Reader

Operation procedures are as follows:

1. Configure the bar code

For more detailed information about configuring the bar code, please refer to Section 9.3.5.2, "Setting Barcode".

NOTE: If the two-dimensional bar code reader is used, you should install Symbol COM Port Emulation Drive manually. For details, please refer to *SE-1010 PC ECG Installation Guide*.

2. Connect the bar code reader to the PC.

3. Log into the PC ECG software.

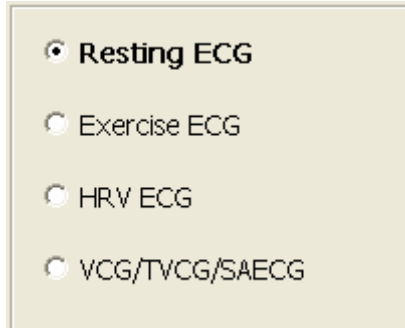
4. When the main screen or the **Patient Information** window is displayed, scan the patient's bar code with the bar code reader, and then the patient information will appear in the corresponding boxes of the **Patient Information** window.

NOTE:

1. Only bar code readers recommended by the manufacturer can be used.
2. Only the basic information of the patient can be scanned by the bar code reader.

6.4 Selecting Sampling Type

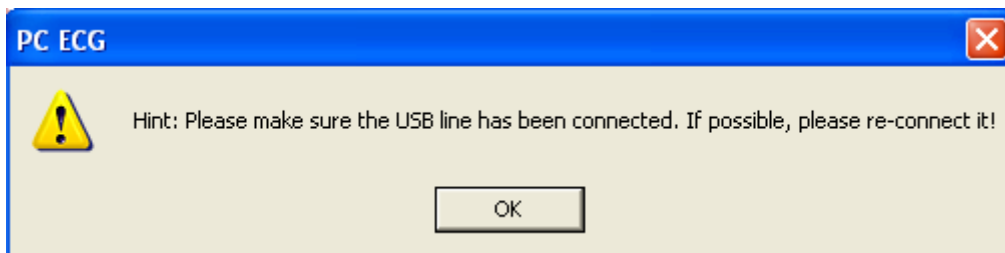
You can select a sampling type in the **Patient information** window.



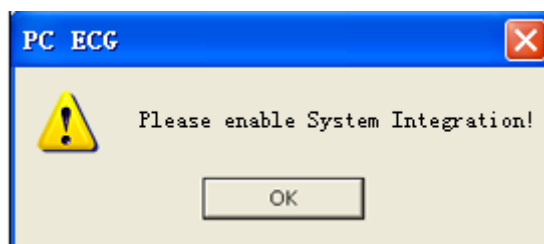
6.5 Sampling Resting ECG

After inputting the patient information, click on the **OK** button in the **Patient information** window to open the ECG sampling screen.

Before sampling, if you do not connect the PC to the ECG sampling box, the following hint will pop up.



If the system is invoked by Smart ECG Net, but the system integration is not activated, the following hint will pop up.



The system begins to pre-sample ECG.

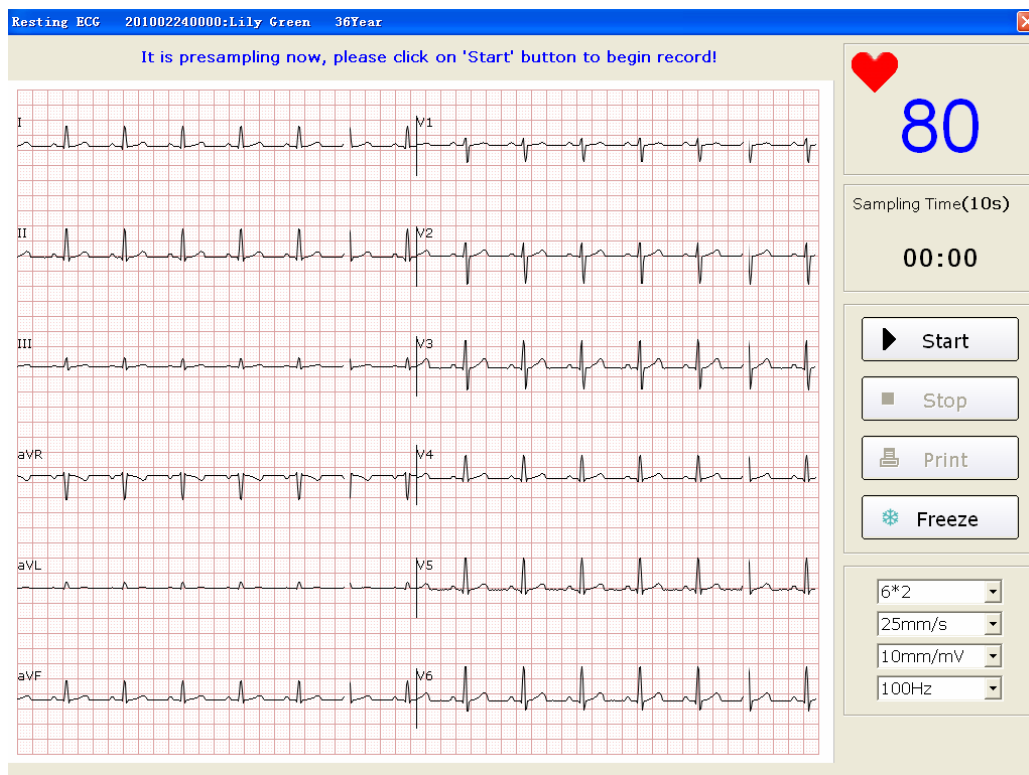
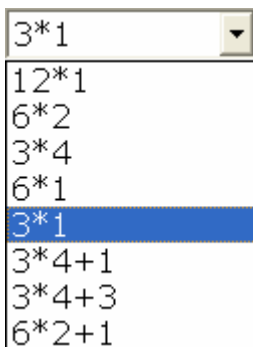


Figure 6-5 Pre-Sampling Screen

6.5.1 Specifying Display Mode



There are eight display modes including **12*1**, **6*2**, **3*4**, **6*1**, **3*1**, **3*4+1**, **3*4+3** and **6*2+1**.

When the display mode is set to **12*1**, 12-channel ECG waves are displayed on one screen simultaneously.

When the display mode is set to **6*2**, 12-channel ECG waves are displayed in 2 groups of 6 on one screen.

When the display mode is set to **3*4**, 12-channel ECG waves are displayed in 4 groups of 3 on one screen.

When the display mode is set to **6*1**, 6-channel ECG waves are displayed on one screen.

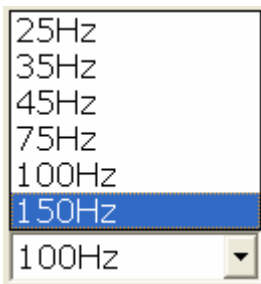
When the display mode is set to **3*1**, 3-channel ECG waves are displayed on one screen simultaneously.

When the display mode is set to **3*4+1**, 12-channel ECG waves are displayed in 4 groups of 3 and one rhythm lead on one screen.

When the display mode is set to **3*4+3**, 12-channel ECG waves are displayed in 4 groups of 3 and three rhythm leads on one screen.

When the display mode is set to **6*2+1**, 12-channel ECG waves are displayed in 2 groups of 6 and one rhythm lead on one screen.

6.5.2 Specifying Lowpass Filter



Lowpass Filter restricts the bandwidth of input signals. The cutoff frequency can be set to **25Hz**, **35Hz**, **45Hz**, **75Hz**, **100Hz**, or **150Hz**. The input signals whose frequency is higher than the set cutoff frequency will be attenuated.

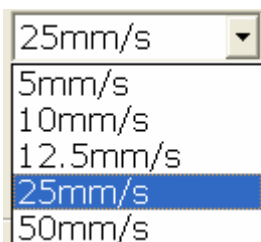
6.5.3 Specifying Gain



You can set the indicated length of 1mV ECG on the paper.

You can set the gain to **2.5mm/mV**, **5mm/mV**, **10mm/mV** or **20mm/mV**.

6.5.4 Specifying Speed



You can set the paper speed to **5mm/s**, **10mm/s**, **12.5mm/s**, **25mm/s** or **50mm/s**.

6.5.5 Recording ECG Data

When the pre-sample ECG waves are steady, you can click on the **Start** button to save the sampled ECG data to the designated directory. For details, please refer Section 9.1.4, “Specifying the Storage Path of the ECG Data”.

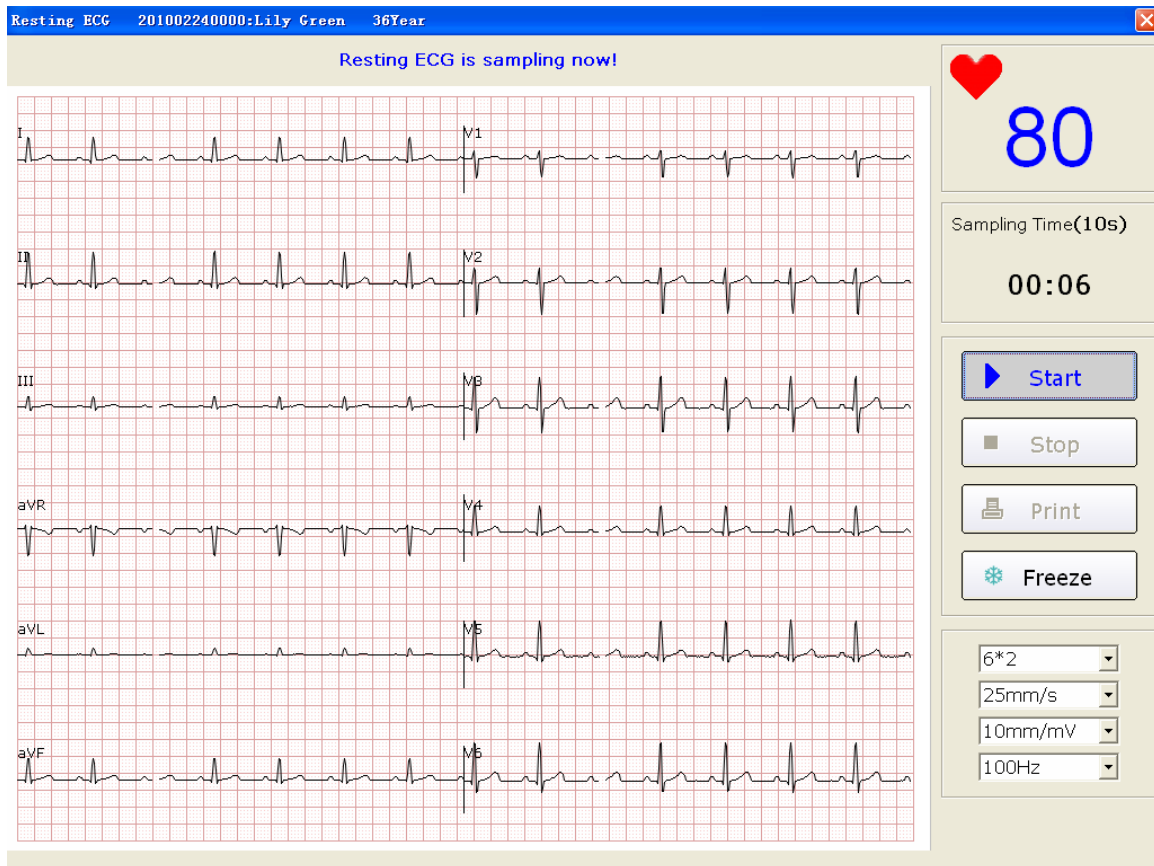


Figure 6-6 ECG Sampling Screen

NOTE: After you click on the **Start** button, the system will save the sampled ECG data. If you don't click on the **Start** button, the system won't save the sampled ECG data.

6.5.6 Freezing and Previewing ECG

Click on the **Freeze** button on the ECG sampling screen (Figure 6-6), the system will display the **Wave review** window. The system can review a 3-minute (at least) waveform (counted from before clicking on the **Freeze** button for 3 minutes). You can review the waveform by dragging the scrollbar and you can print the current waveform by clicking on the **Print** button.

NOTE: Printing ECG reports in the **Wave review** window are only available for Resting ECG and Exercise ECG.

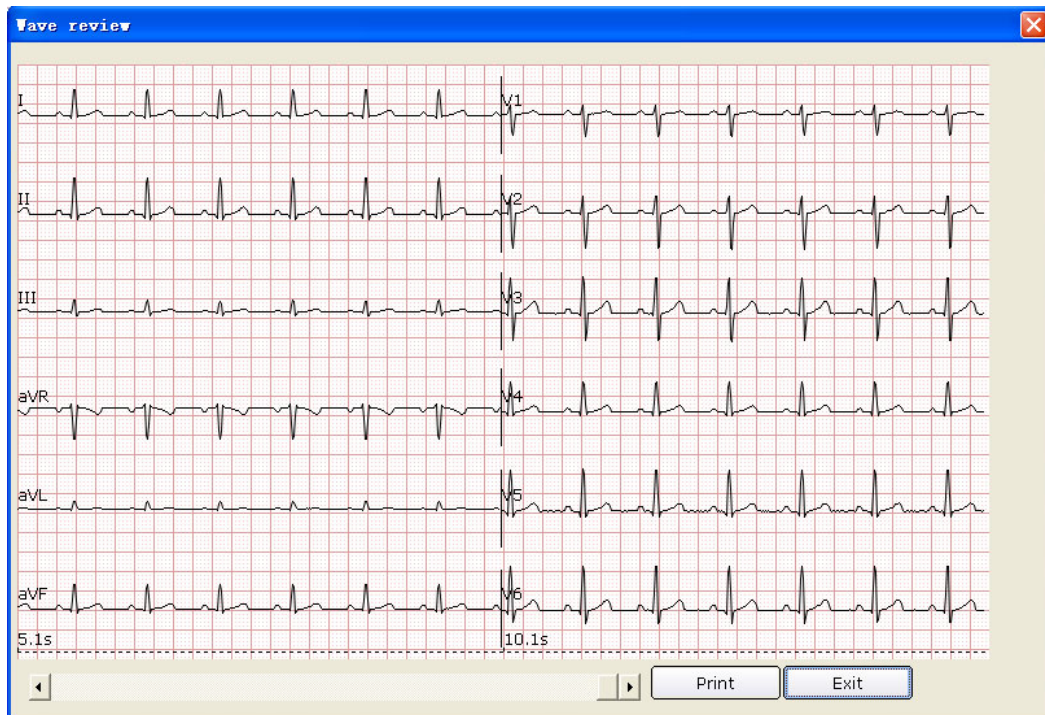


Figure 6-7 Wave Review Window

Click on **Exit** to return to the ECG sampling screen.

NOTE: The display modes in the **Wave review** window are the modes you select on the ECG sampling screen. 3*1 and 6*1 display modes are displayed in 3*4 and 6*2 modes.

6.5.7 Stopping Sampling Data

After clicking on the **Start** button, there are two ways to stop sampling data.

1. The system will stop sampling ECG data and display the ECG analysis screen automatically after the ECG sampling time is over. For details, please refer to Section 9.2.2, "Setting Sampling Time".
2. Before the ECG sampling time is over, you can click on the **Stop** button to stop sampling data and the ECG analysis screen will pop up automatically.

6.5.8 Printing ECG Waves

Click on the **Print** button on the ECG sampling screen to print the ECG waves on the ECG sampling screen.

NOTE:

1. You can set the printer type on the **Printer and Faxes** screen. For details, please refer to Section 6.6.10, "Printing ECG Reports".
2. The report can be printed in **white- black** or **color**. The report color is defined by setting the printer type and can be observed on the preview screen. For details, please refer to Section 9.4.4, "Print Setup".

6.6 Analyzing ECG Data

You can open the ECG analysis screen in one of the following three ways:

1. Click on the **Start** button, and then the system will stop sampling ECG and display the ECG analysis screen automatically after the ECG sampling time is over.
2. Or, click on the **Stop** button to stop sampling after clicking on the **Start** button, and the system will display the ECG analysis screen automatically.
3. Or, double-click on an examination record in the examination record list on the **Data Manager** screen (Figure 6-3) to open the ECG analysis screen.

When **Resting ECG** is selected as the sampling type, the ECG analysis screens include Normal ECG, QT Dispersion (QTD), Frequency ECG (FCG) and High Frequency ECG (HF ECG).

When **HRV ECG** is selected as the sampling type, the ECG analysis screens include Heart Rate Variability (HRV) and Heart Rate Turbulence (HRT).

When **VCG/TVCG/SAECG** is selected as the sampling type, the ECG analysis screens include Vector ECG (VCG), Time Vector ECG (TVCG) and Signal Averaged ECG (SAECG).

6.6.1 Analyzing Normal ECG

Click on the **Normal Analysis** button to open the normal ECG analysis screen. There are four tabs: **Waveform**, **Average Template**, **Detail information** and **Rhythm Wave**.

6.6.1.1 Viewing the Waveform

Click on the **Waveform** tab on the normal ECG analysis screen to open the **Waveform** window (Figure 6-8).

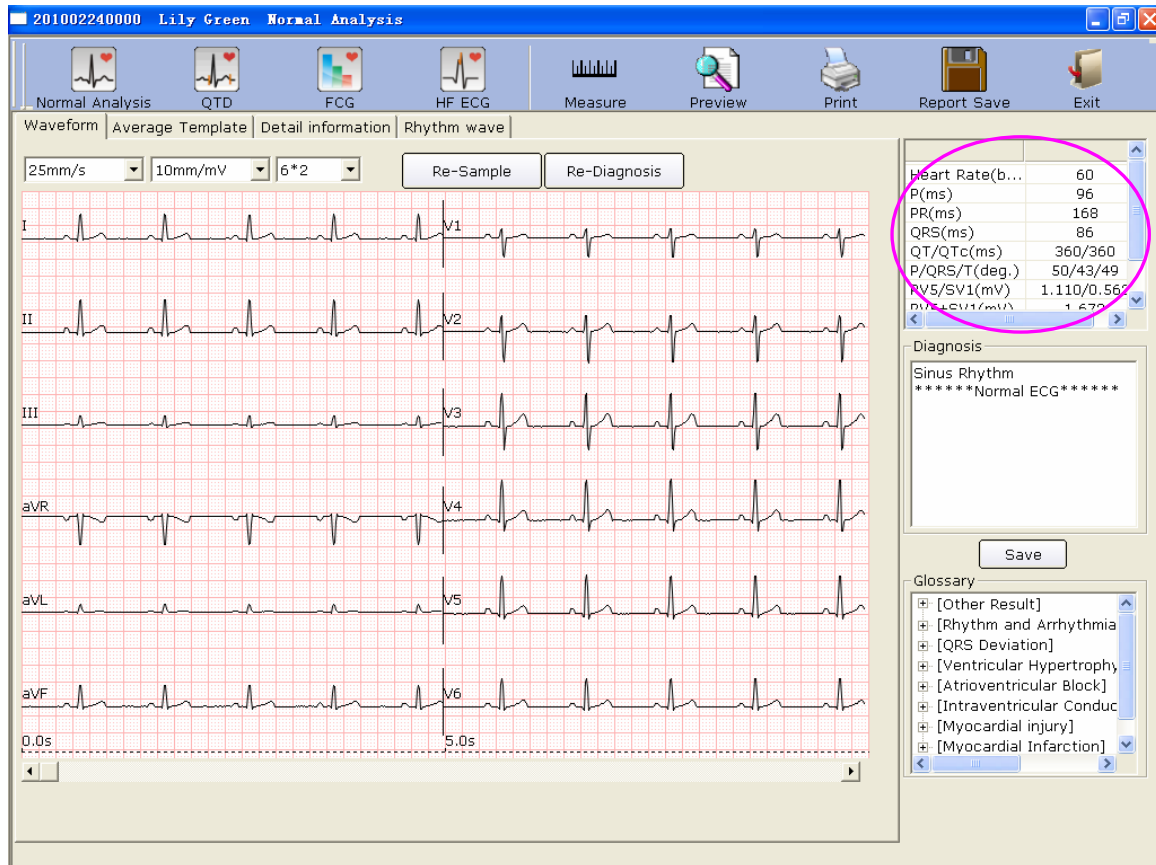


Figure 6-8 Normal ECG - Waveform Window

You can choose a speed, a gain and a display mode for the displayed waves.

Click on the **Measure** button in the **Waveform** window (Figure 6-8). Click on one point on the wave, and then drag the mouse to another point. The distance, amplitude difference and heart rate between the two points will be displayed.

NOTE:

1. You can measure the distance between any two points more than once after running the ruler. The last measure track and data will be displayed after the measurement.
2. Only ECG waves can be measured.

Click on **Re-Sample**, and then the system can re-sample ECG data.

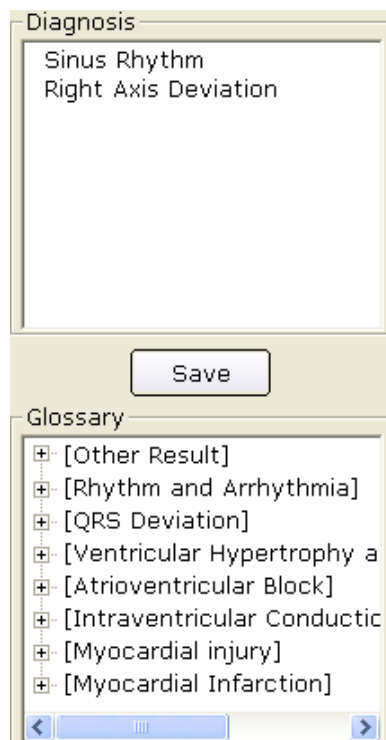
Click on **Re-Diagnosis**, and then the system can re-diagnose the 10s ECG data on the screen automatically.

The common parameters are displayed in the circle in Figure 6-8. These parameters are as follows.

Designation	Description
Heart Rate	Heart Rate
P Duration	P-wave duration of the current lead
PR Dur.	P-R interval of the current lead
QRS Dur.	QRS complex duration of the current lead
QT/QTc	Q-T interval of the current lead/Normalized QT interval
P/QRS/T	Dominant direction of the average integrated ECG vectors
RV5/SV1	The amplitude of R wave of V5 lead/the amplitude of S wave of V1 lead
RV5+SV1	The amplitude of R wave of V5 lead plus the amplitude of S wave of V1 lead
RV6/SV2	The amplitude of R wave of V6 lead/the amplitude of S wave of V2 lead

Double-click on a parameter, and then you can modify it. Then click on the **Save** button to save the modifications.

To Edit Diagnosis Result in the Waveform Window



1. Enter your own opinions in the **Diagnosis** textbox, and then click on the **Save** button.
2. Or, double-click on the necessary results required to be added in the **Glossary** textbox, the selected results will be displayed in the **Diagnosis** textbox, and then click on the **Save** button.

If the Integration function is activated, the data can be uploaded to Smart ECG Net system after you click on the **Save** button.

6.6.1.2 About the Average Template Window

Click on the **Average Template** tab on the normal ECG analysis screen to open the **Average Template** window (Figure 6-9). You can analyze average templates in this window.

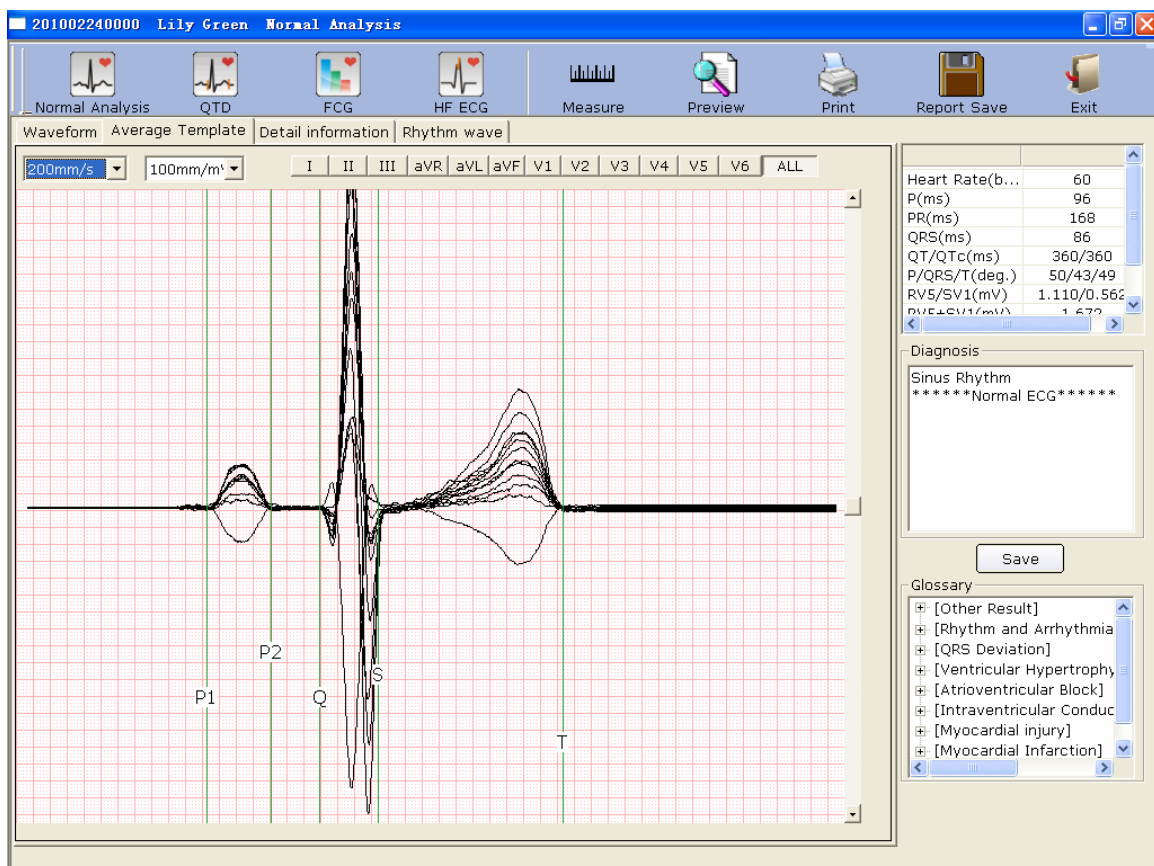
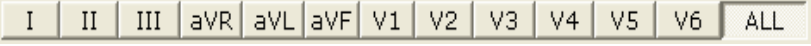
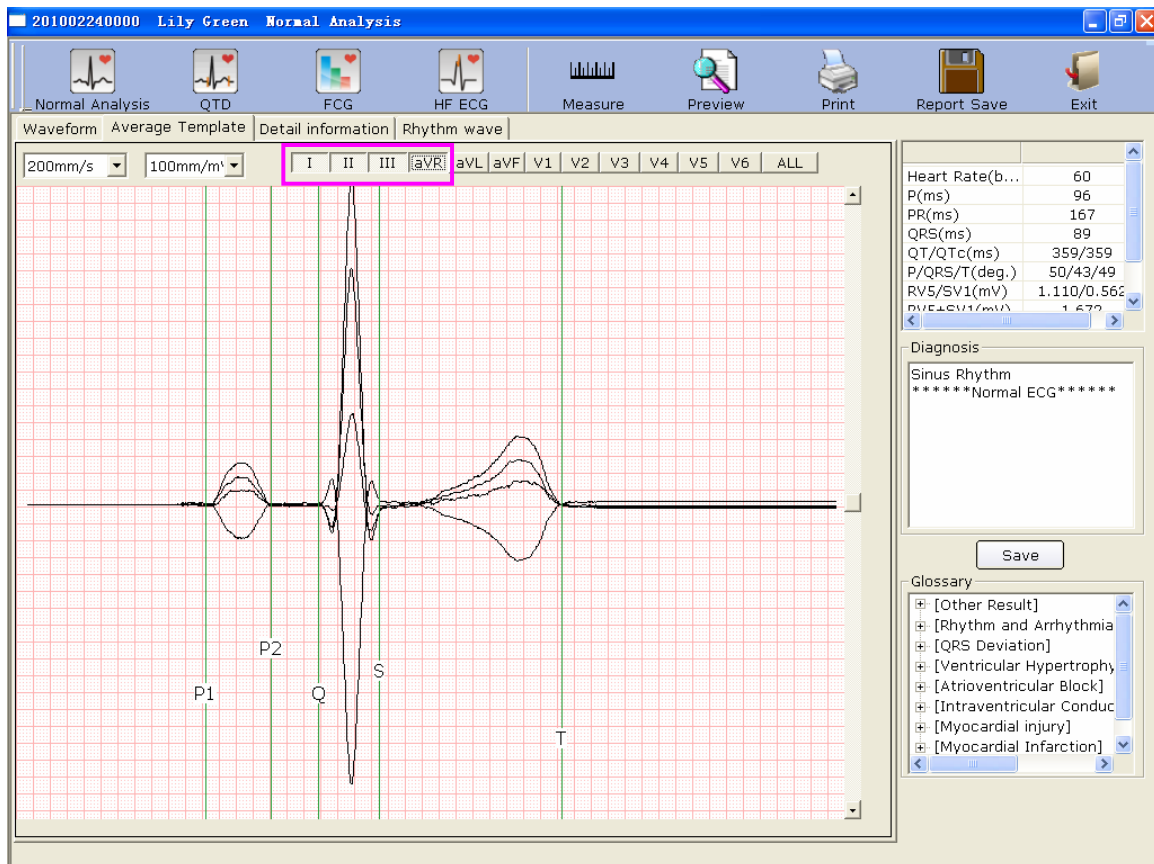


Figure 6-9 Normal ECG - Average Template Window

To Edit Waveform on the Analysis Screen

You can press a lead button in  to display magnified average templates of this lead. When you press more than one lead button, magnified average templates of these leads will be overlapped with the same central axis.



When you press **ALL**, magnified average templates of all leads will be overlapped with the same central axis.

You can set the speed and the gain of average templates.

You can drag marker lines of P1, P2, Q, S and T on average templates.

P1 is the start point of P wave, P2 is the end point of P wave, Q marks the position of Q point, S marks the position of S point, and T is the end point of T wave. You can move these lines by dragging on the mouse and the mouse will turn to a hand pointer when it is put on these marks. You can also use the arrows key on the keyboard to move these marks, and the corresponding parameter values will change.

To Edit Diagnosis Result in the Average Template Window

For details, please refer to Section 6.6.1.1, “Viewing the Waveform”.

6.6.1.3 About the Detail Information Window

Click on the **Detail information** tab on the normal ECG analysis screen to open the **Detail information** window. This window displays lead parameter values as Figure 6-10 shows.

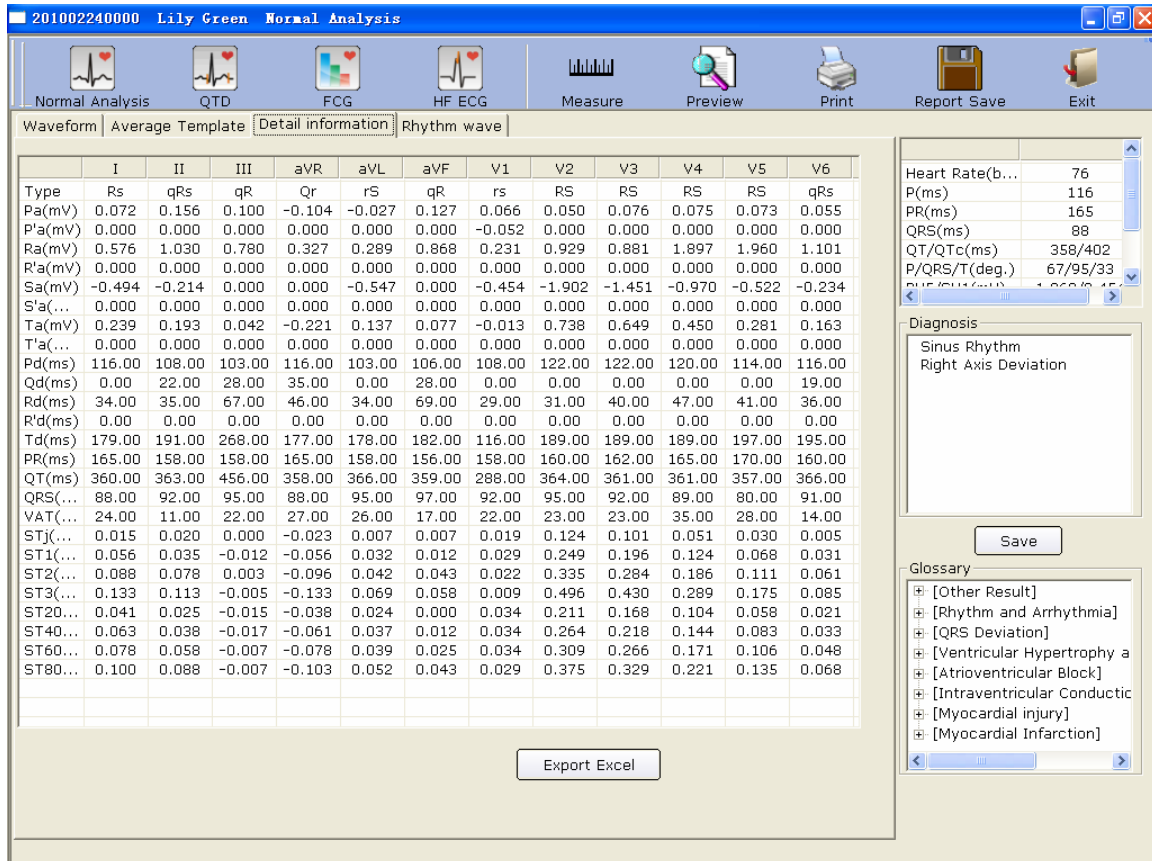


Figure 6-10 Normal ECG - Detail Information Window

Click on the **Export Excel** button to export an Excel file.

To Edit Diagnosis Result in the Detail Information Window

For details, please refer to Section 6.6.1.1, “Viewing the Waveform”.

6.6.1.4 About the Rhythm Wave Window

Click on the **Rhythm Wave** tab on the normal ECG analysis screen to open the **Rhythm wave** window. This window displays rhythm wave as Figure 6-11 shows.

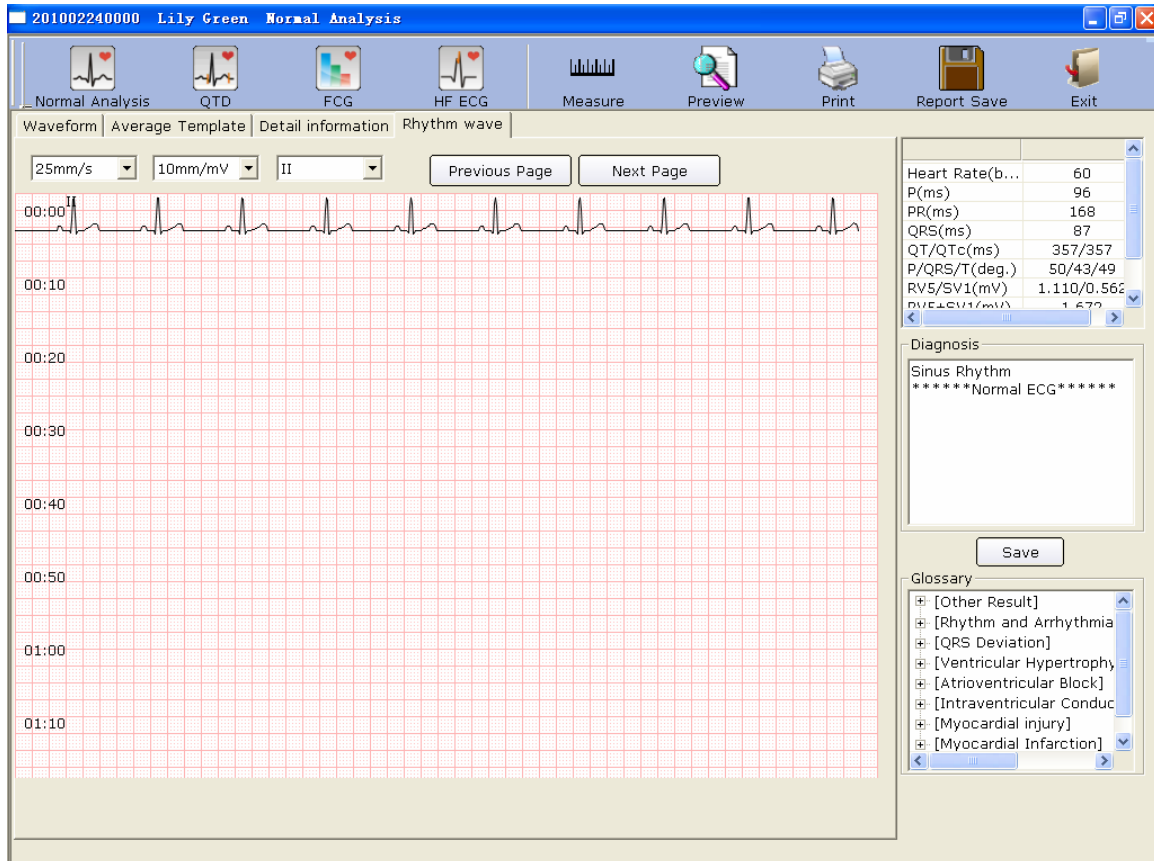


Figure 6-11 Normal ECG - Rhythm Wave Window

You can set the gain, the speed and the lead of the displayed ECG waves.

You can click on **Previous Page** or **Next Page** to display the waves of the previous or next page.

Click on one point on the wave, and then drag the mouse to another point. Then click on **Print** to print the selected wave field.

6.6.1.5 Previewing Normal ECG

Click on the **Preview** button to display the normal ECG preview screen.



is the toolbar on the normal ECG preview screen.

1. Click on **Previous Page/Next Page** to switch to the previous/next preview page.
2. Click on **Zoom In/ Zoom Out** to magnify/minify the preview page.
3. Click on **Print** to print the report.

4. Click on **Close** to close the normal ECG preview screen and return to the previous screen.

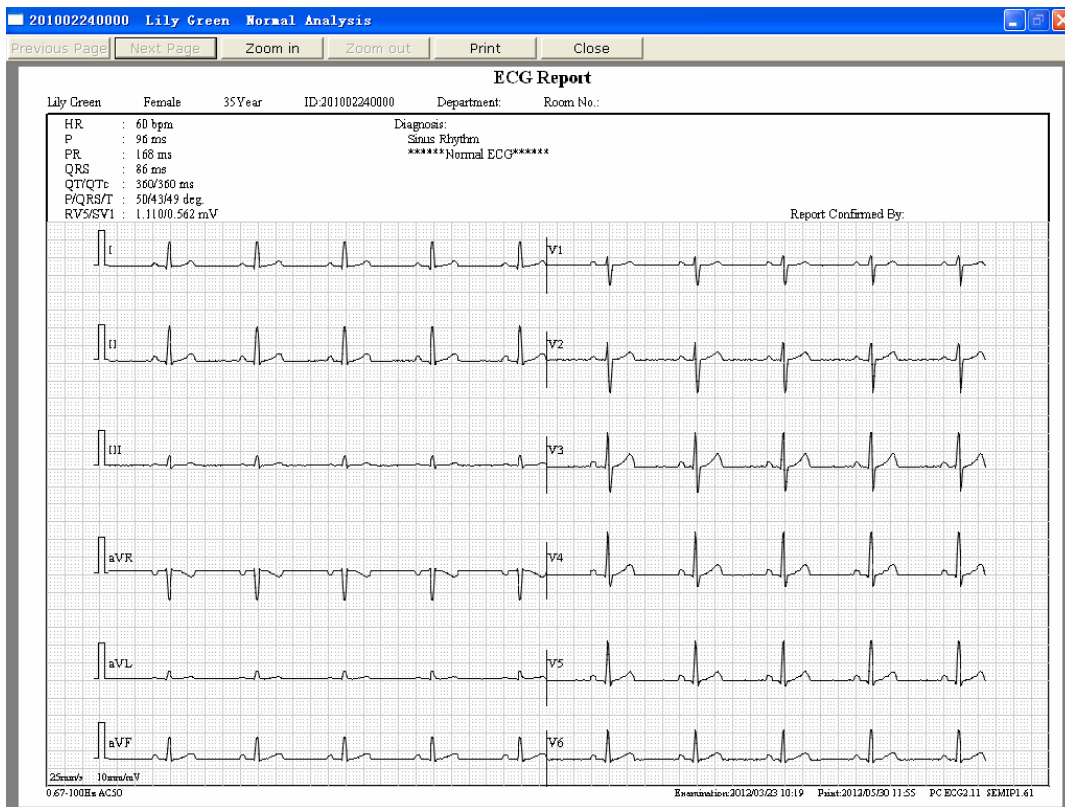
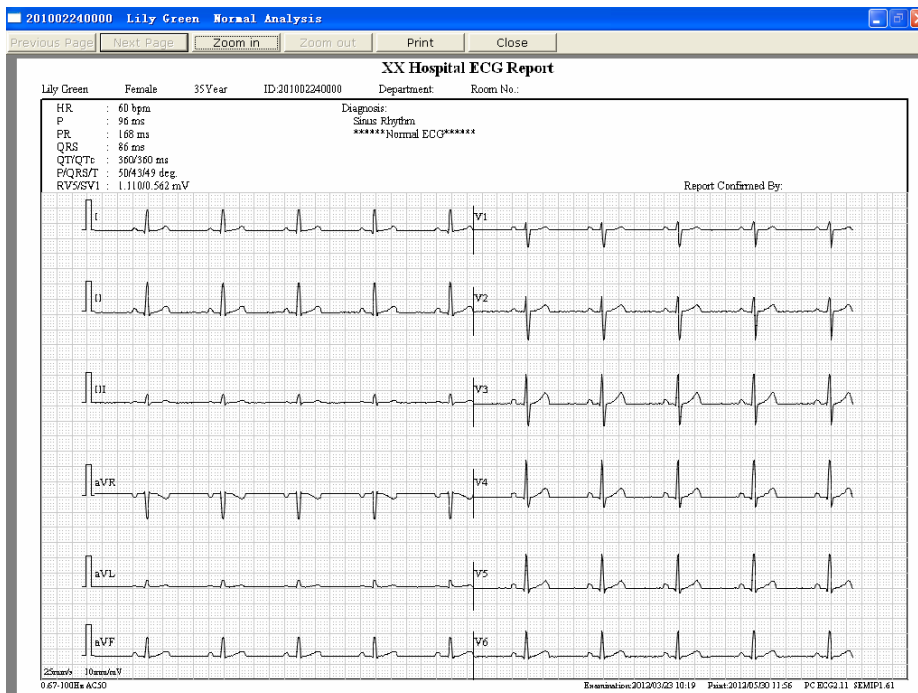


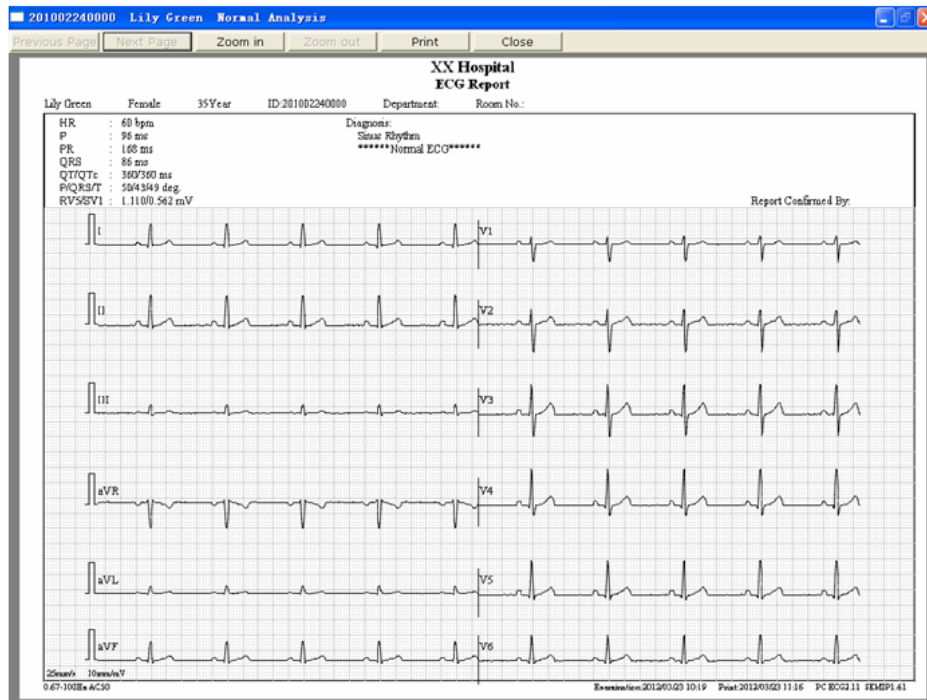
Figure 6-12 ECG Wave

NOTE: The report title is in one line by default, you can also change the line to two lines. Find the text named **PCECG.ini** in the installation path, modify **LineofTitle=0** to **LineofTitle=1**, and then save the text to change the line to two lines.

Effect pictures of report title are as shown below:



Report Title in One Line



Report Title in Two Lines

6.6.2 Analyzing QT Dispersion

Click on the **QTD** button to open the QT Dispersion screen.

QT Dispersion: The difference between the largest QT interval and the shortest QT interval based on the synchronous 12-lead surface ECG. The QT interval is a measurement of the time difference between the start of the Q wave and the end of the T wave.

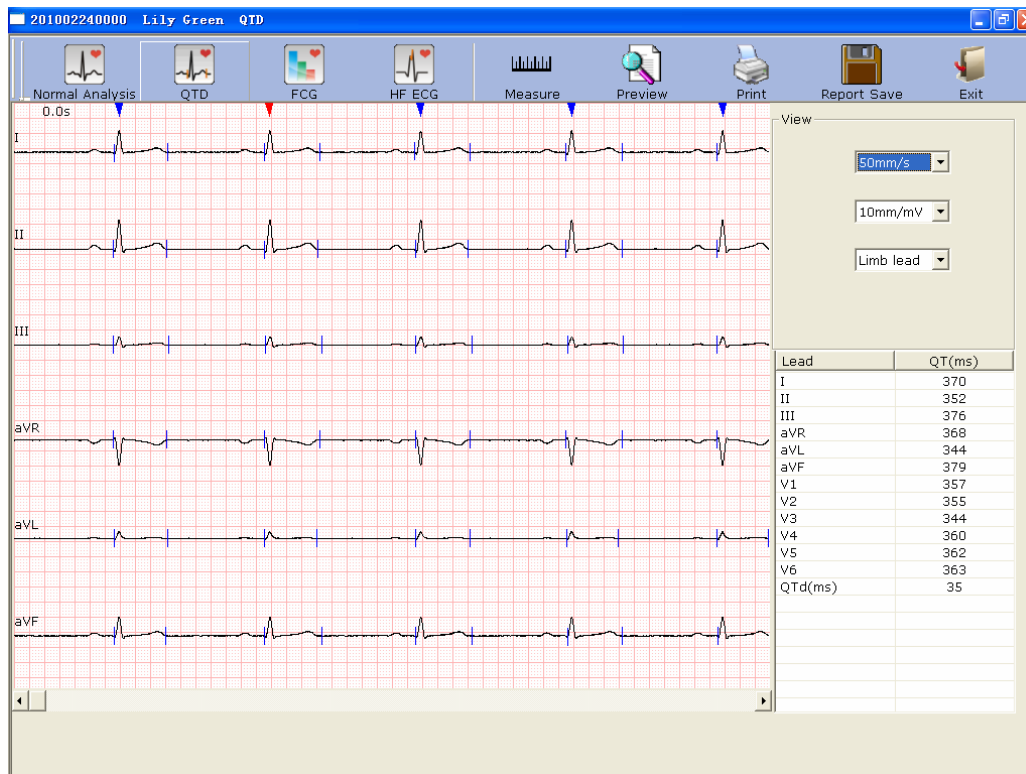


Figure 6-13 QT Dispersion screen

6.6.2.1 Editing Waveform on the QT Dispersion Screen

There are red and blue triangle icons on top of the displayed ECG waves. You can click on the triangle icon to change the color.



represents the current chosen R wave



represents the position of R wave



You can set the speed and the gain of the displayed ECG waves. The lead number and the lead type of the displayed ECG waves can also be chosen.

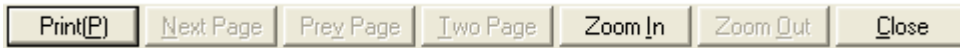
6.6.2.2 About QT Value

Lead	QT(ms)
I	358
II	360
III	350
aVR	358
aVL	358
aVF	360
V1	377
V2	366
V3	363
V4	355
V5	354
V6	353
QTd(ms)	27

QT values of 12 leads and QT dispersion (QTd) are displayed as the left figure shows.

6.6.2.3 Previewing QT Dispersion

Click on the **Preview** button on the QT Dispersion screen to open the QT Dispersion preview screen.



is the toolbar on the

QT Dispersion preview screen.

1. Click on **Print(P)** to print the report.
2. Click on **Next Page/Prey Page** to switch to the previous/next preview page.
3. Click on **Two Page** to preview two pages on one screen simultaneously.
4. Click on **Zoom In/ Zoom Out** to magnify/minify the preview page.
5. Click on **Close** to close the preview screen and return to the previous screen.

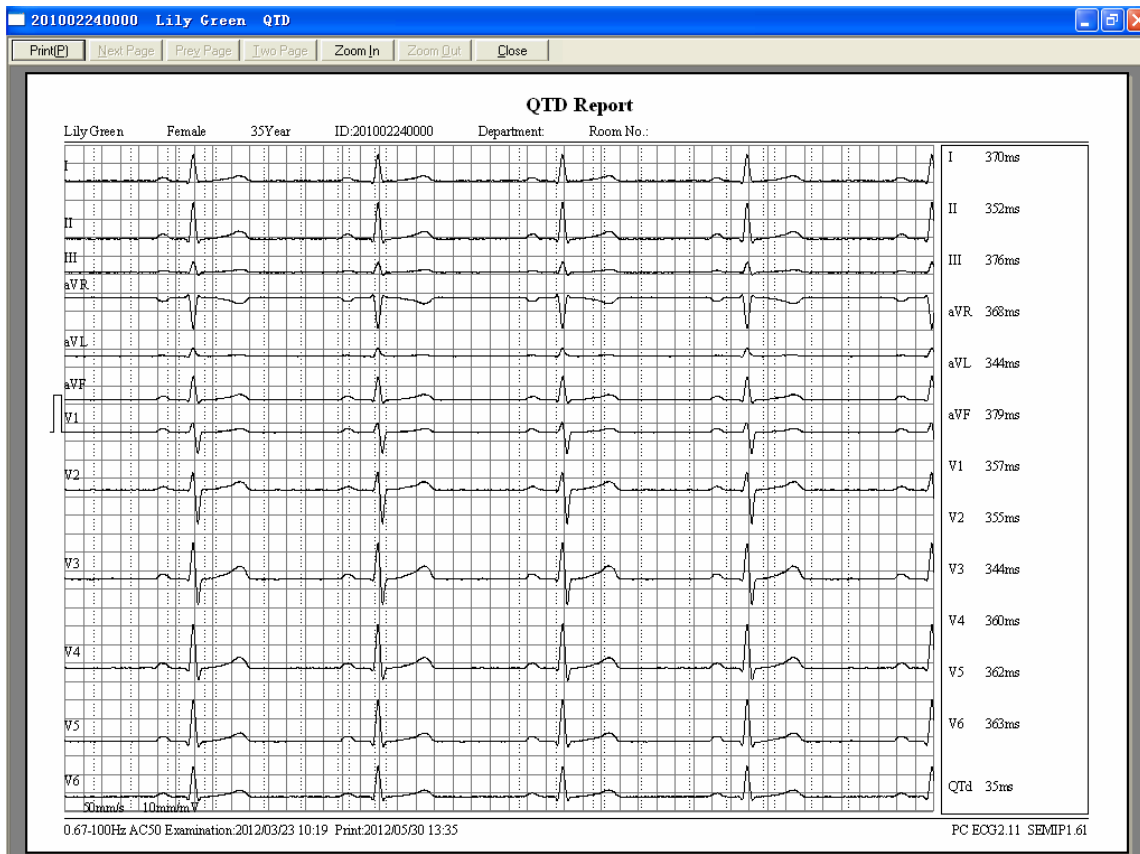


Figure 6-14 QT Dispersion Preview Screen

6.6.3 Analyzing Frequency ECG

Click on the **FCG** button to open the Frequency ECG screen.

Frequency ECG displays characteristic waves of ECG signal spectrum.

There are two tabs on the Frequency ECG screen: **Two leads compare** and **12-lead power spectrum**.

6.6.3.1 About Two-lead Comparison Window

The two-lead comparison window displays the power spectrum, phase shift, amplitude shift, coherence, impulse response and correlation functions of ECG waves, as Figure 6-15 shows.

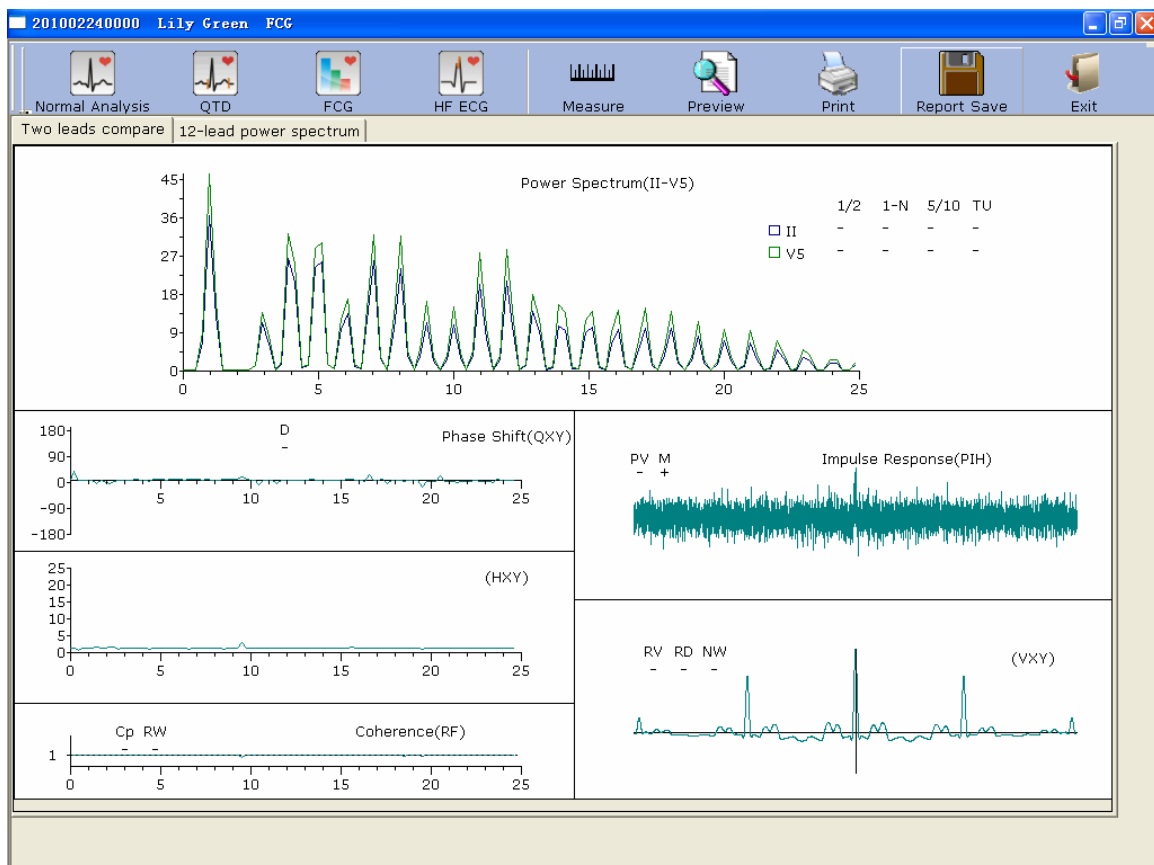


Figure 6-15 Frequency ECG - Two-lead Comparison Window

Every parameter of Frequency ECG is shown in the following table.

	Designation	Definition
Power Spectrum	1/2	If the first peak value is lower than 90% of the second peak value, it is positive ('+'). Otherwise it is minus ('-').
	1-N	The first peak is too low or disappears. (The frequency value of the first peak's position * 60 = heart rate. For example, if the frequency value of the first peak's position is 1.2, the heart rate is 72.)
	5/10	If the peak value of any peak behind the fifth peak is higher than the first peak value, it is positive. Otherwise it is minus.
	TU	If the distances between peak values are not equal, it is positive. Otherwise it is minus.
Phase Shift	D	If the phase shift in the range of 6~18Hz exceeds 90 degrees, it is positive. Otherwise it is minus.
Coherence	Cp	If the coherence value of the fundamental (the position of the first peak in power spectrum) is less than 0.8, it is positive. Otherwise it is minus.
	RW	If there are four twists and turns with peak-to-valley interval >0.5r or five twists and turns with peak-to-valley interval >0.1 in the range of 10~20Hz, it is positive. Otherwise it is minus.
Impulse Response	PV	If the main peak in the middle upends, the downward peak value is higher than the upward peak value, it is positive. Otherwise it is minus.
	M	If there is a peak around the main peak higher than 60% of the main peak, it is positive. Otherwise it is minus.
Correlation Function (VXY)	RV	If the main peak in the middle upends, it is positive. Otherwise it is minus.
	RD	If the main peak in the middle deviates from the origin and the baseline, it is positive. Otherwise it is minus.
	NW	The main peak is like the letter 'N'.

6.6.3.2 About 12-lead Power Spectrum Window

The **12-lead power spectrum** window displays the power spectrum of 12-lead ECG waves.

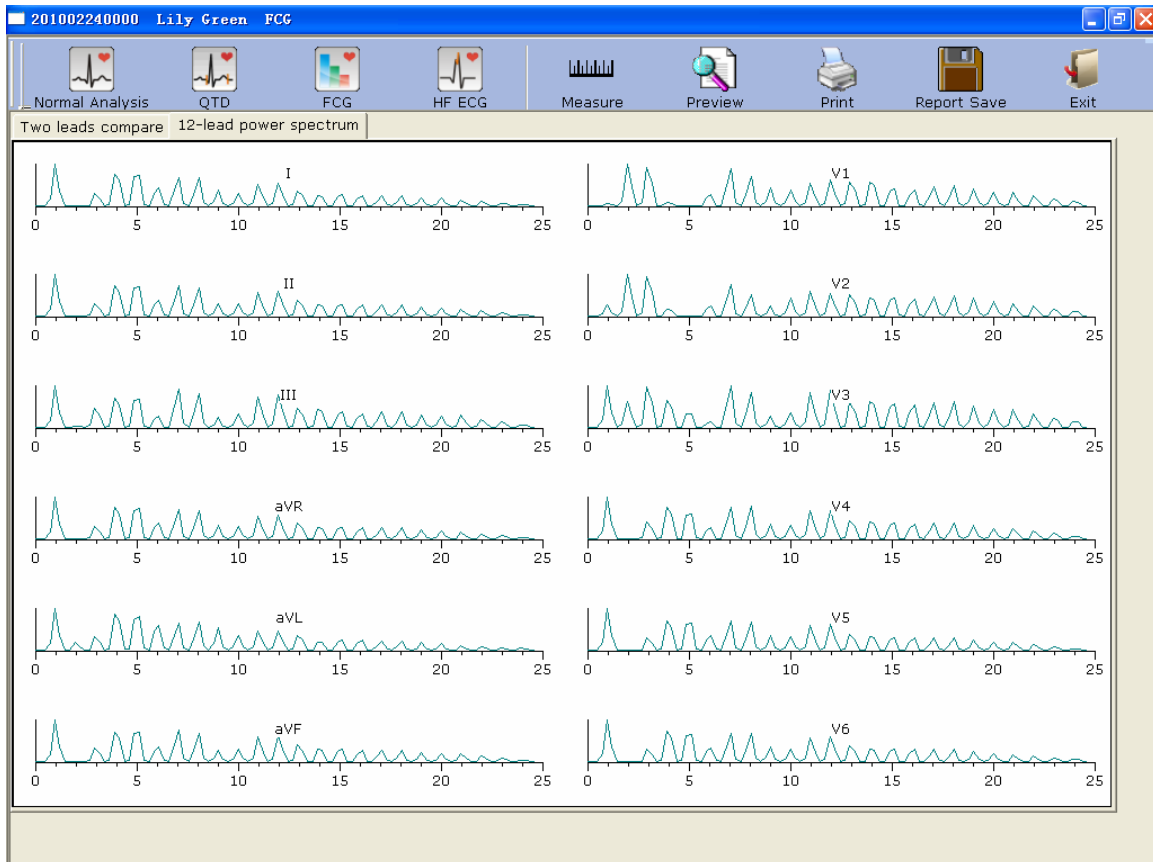
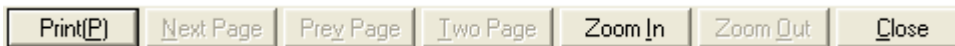


Figure 6-16 Frequency ECG - 12-lead Power Spectrum Window

6.6.3.3 Previewing Frequency ECG

Click on the **Preview** button to open the Frequency ECG preview screen.



is the toolbar on the

Frequency ECG preview screen.

1. Click on **Print(P)** to print the report.
2. Click on **Next Page/Prey Page** to switch to the previous/next preview page.
3. Click on **Two Page** to preview two pages on one screen simultaneously.
4. Click on **Zoom In/ Zoom Out** to magnify/minify the preview page.
5. Click on **Close** to close the preview screen and return to the previous screen.

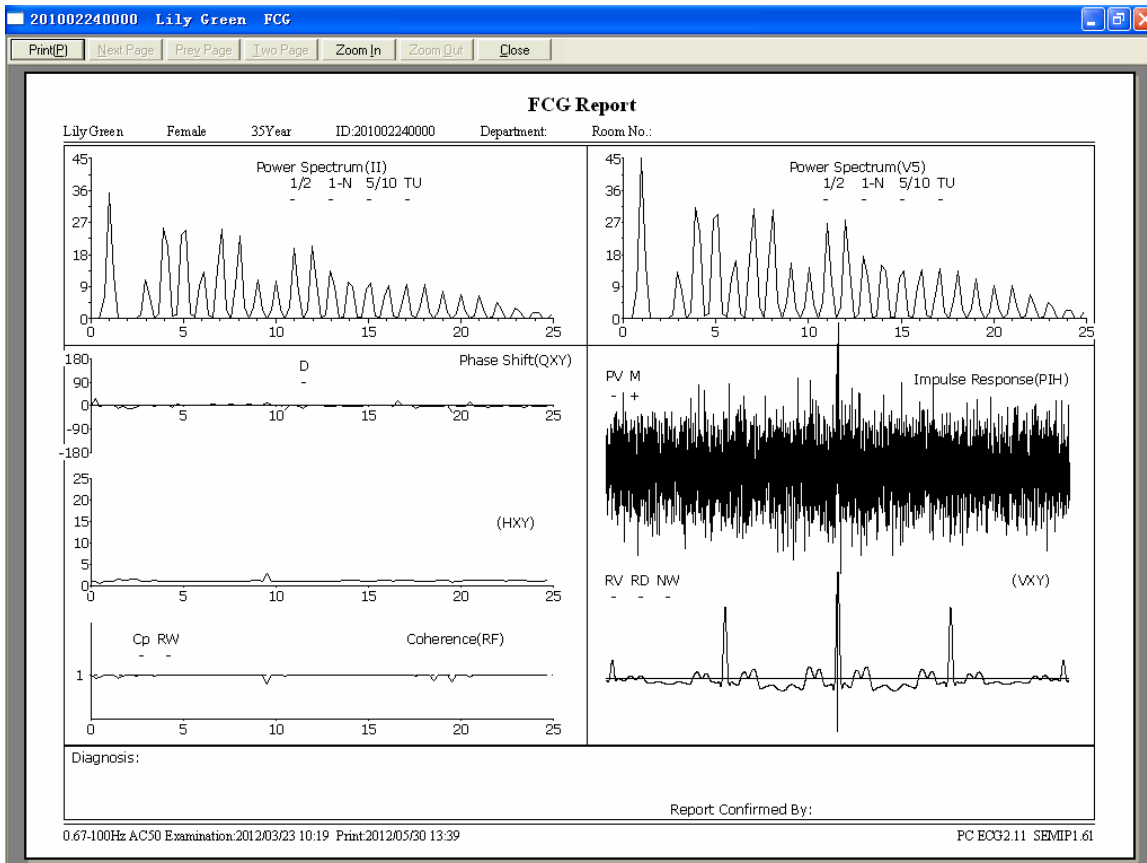


Figure 6-17 Two-lead Comparison Report

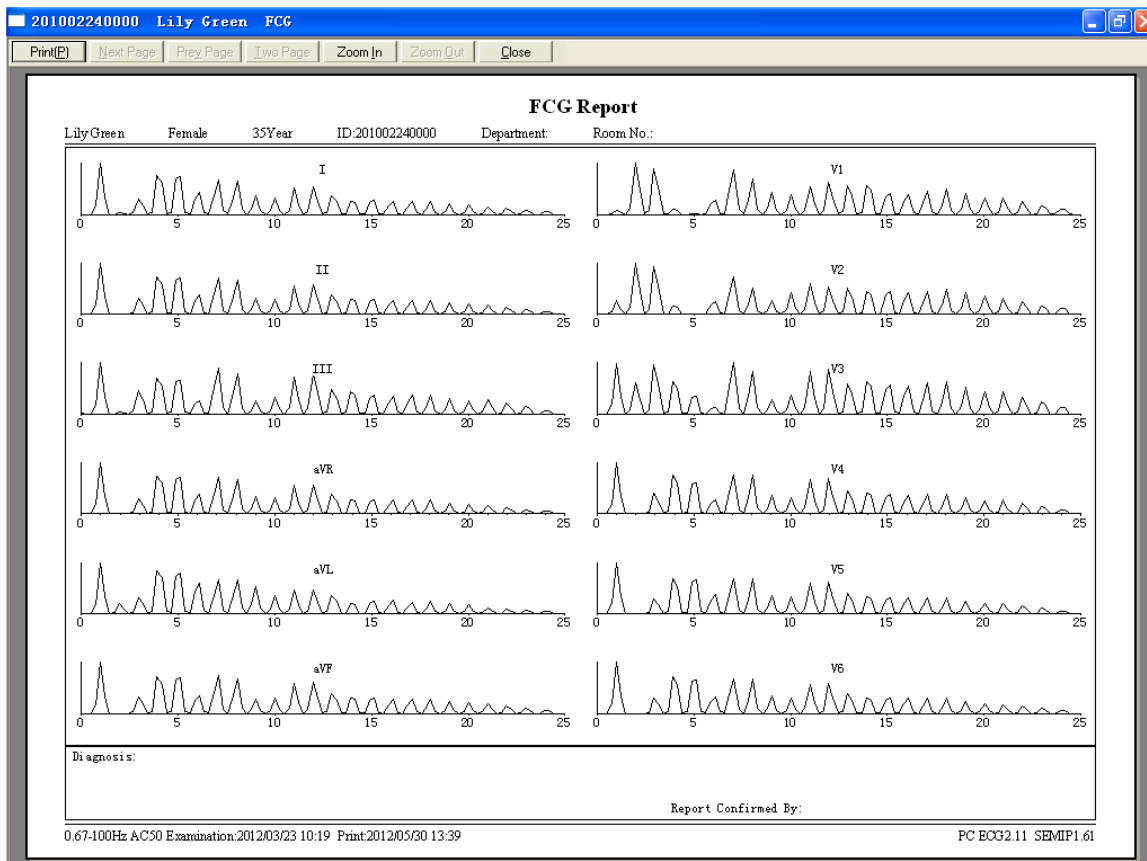


Figure 6-18 12-lead Power Spectrum Report

6.6.4 Analyzing High Frequency ECG

In a conventional electrocardiogram, only these ECG signals, of which the amplitude is in the millivolt range and the frequency is less than 100 Hz, are visible. Those ECG signals, of which the amplitude is in the microvolt range and the frequency is between 150Hz and 250Hz, are invisible. If these invisible high frequency components are abnormal, it is the indication of myocardial ischemia or myocardial infarction.

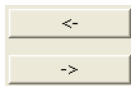
HF ECG is to detect high frequency components of QRS such as notches, slurs and beatings.

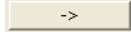
Click on the **HF ECG** button to open the HF ECG analysis screen.

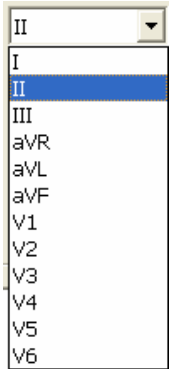


Figure 6-19 HF ECG Analysis Screen

The ECG wave between the two green lines is the present one.



Click on  to select another QRS wave. Select the present lead in the pull-down list



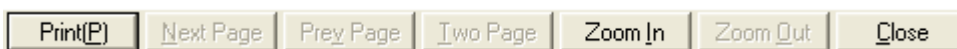
You can choose the lead group, the gain and the speed of the waves displayed in the bottom part of the HF ECG analysis screen.

	I	II	III	aVR	aVL	aVF	V1	V2	V3	V4	V5	V6	Tot.
N	0	0	0	0	3	0	0	0	0	0	0	0	3
S	0	0	0	0	0	0	0	0	0	0	0	0	0
B	0	0	0	0	0	0	0	0	0	0	0	0	0

is the statistic data

of beatings, notches and slurs. You can change a value by double-clicking on the value.

Click on the **Preview** button to open the HF ECG preview screen.



is the toolbar on the

HF ECG preview screen.

1. Click on **Print(P)** to print the report.
2. Click on **Next Page/Prey Page** to switch to the previous/next preview page.
3. Click on **Two Page** to preview two pages on one screen simultaneously.
4. Click on **Zoom In/ Zoom Out** to magnify/minify the preview page.
5. Click on **Close** to close the preview screen and return to the previous screen.

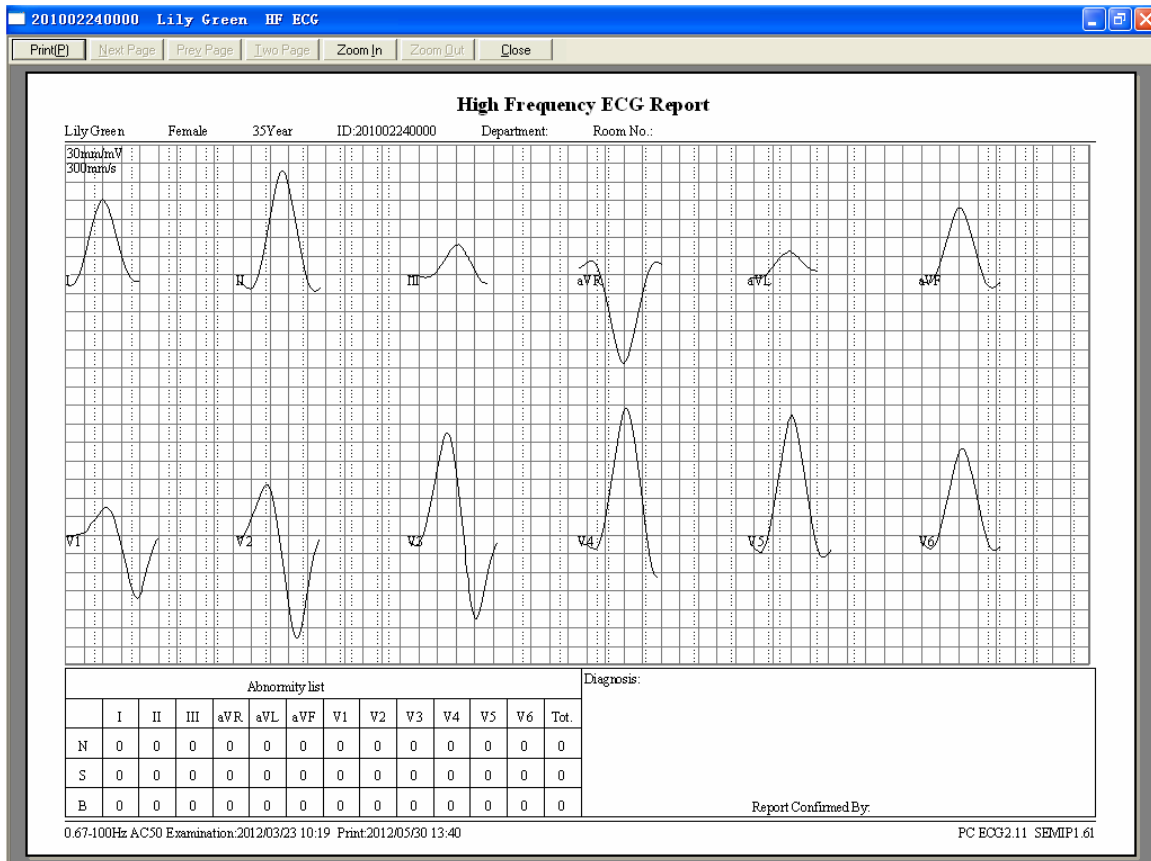


Figure 6-20 HF ECG Report

6.6.5 Analyzing HRV

Click on **HRV** to display the HRV ECG analysis screen. The HRV ECG analysis screen includes two tabs: **Auto diagnosis result** and **Waveform**.

NOTE:

1. The HRV sampling time can be set in the **Sample Setting** window.
2. The HRV analysis lead can be selected in the **Sample Setting** window.

6.6.5.1 Editing the HRV Data on the Analysis Screen

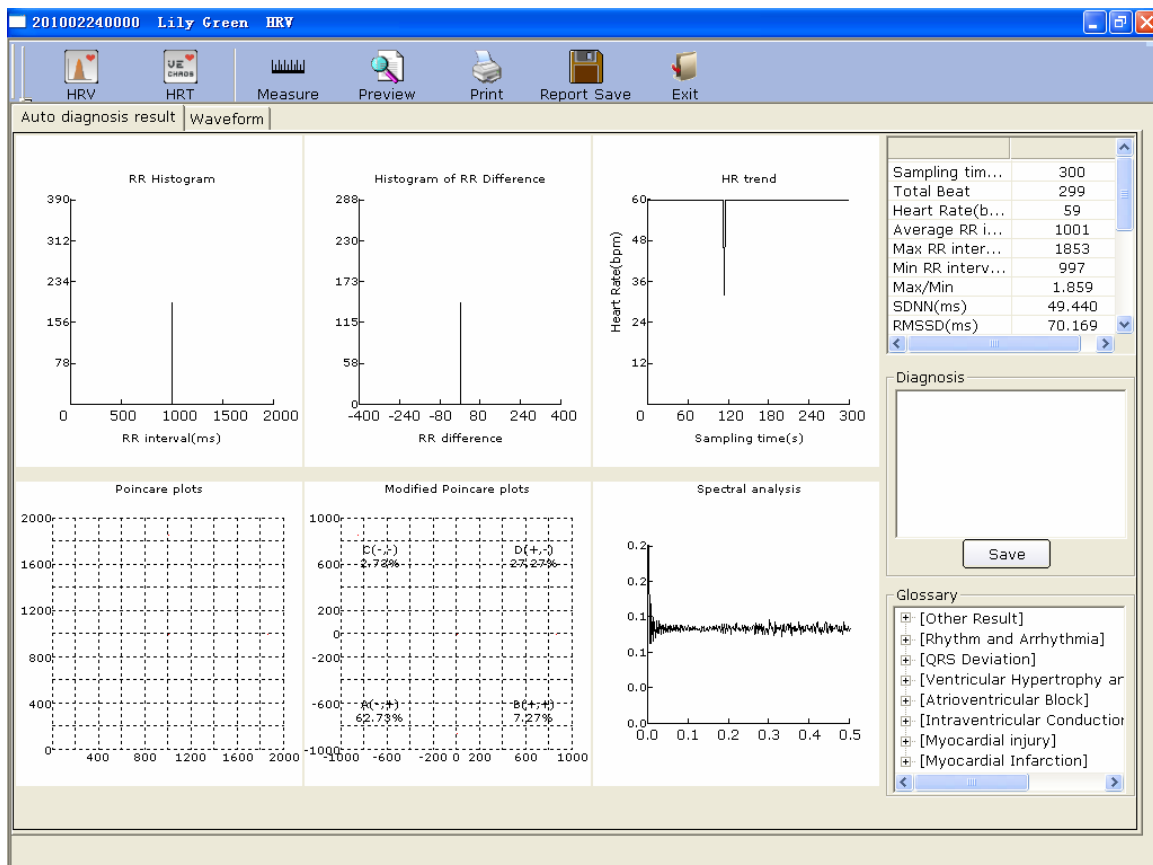


Figure 6-21 Analysis Screen of HRV

Designation	Definition
Sampling time	Set sampling time
Total Beat	Total beat number during the measuring course
Heart Rate	Heart rate
Average RR interval	Average RR interval
Max RR interval	Maximum RR interval
Min RR interval	Minimum RR interval
Max/Min	Ratio of Maximum RR interval to Minimum RR interval
SDNN	Standard Deviation of Normal to Normal Intervals
RMSSD	Root Mean Square Successive Difference
NN50 (the total beat number)	The number of duration difference that is more than 50ms between the adjacent NN durations.
PNN50 (unit: per centum)	NN50 divide the total NN number

LF	Low Frequency
HF	High Frequency
LF/HF	Ratio of low frequency to high frequency
LF (norm)	Standard LF power
HF (norm)	Standard HF power

H- Doctor Diagnosis Field

1. Enter your own opinions in the **Auto diagnosis** textbox, and then click on the **Save** button.
2. Or, double-click on the necessary results required to be added in the **Glossary** textbox, the selected results will be displayed in the **Auto Diagnosis** textbox, and then click on the **Save** button.

6.6.5.2 Editing the HRV Waveform in the Waveform Window

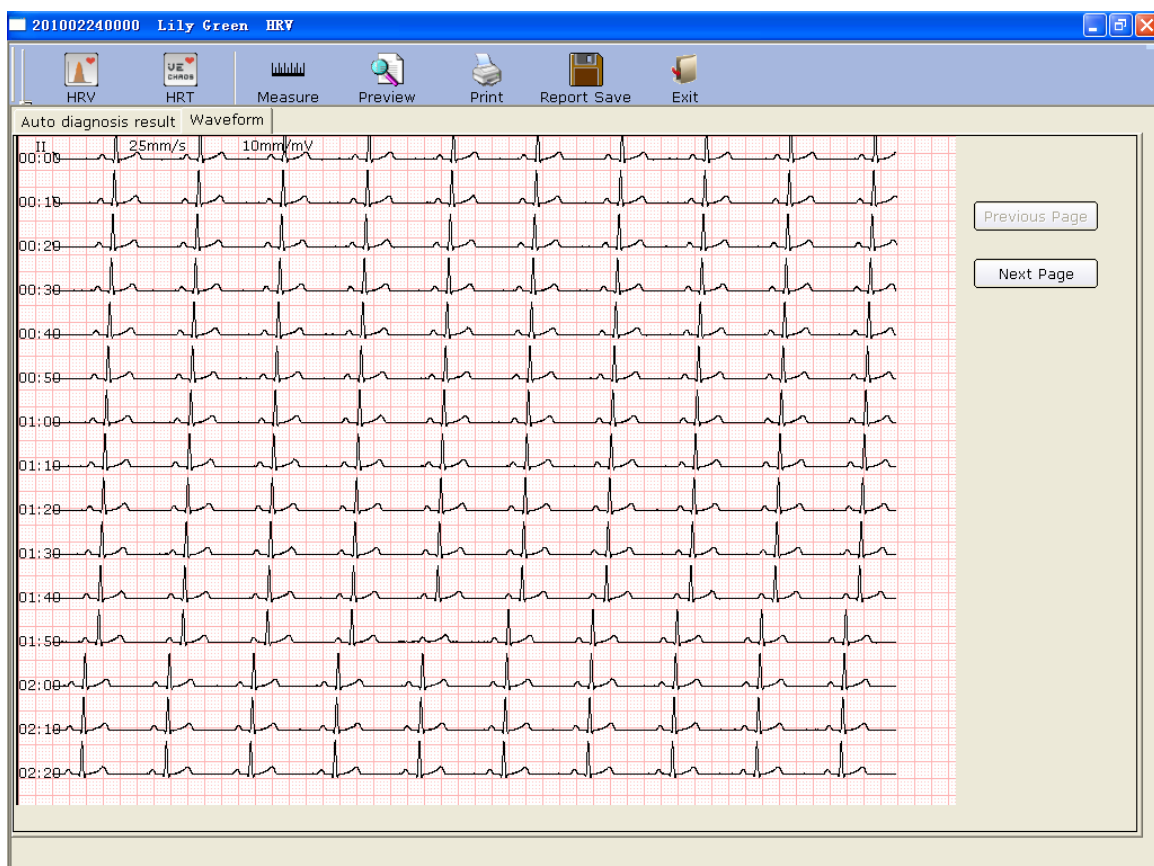



Figure 6-22 Waveform Window of HRV

HRV waveform is displayed in the **Waveform** window (Figure 6-22).

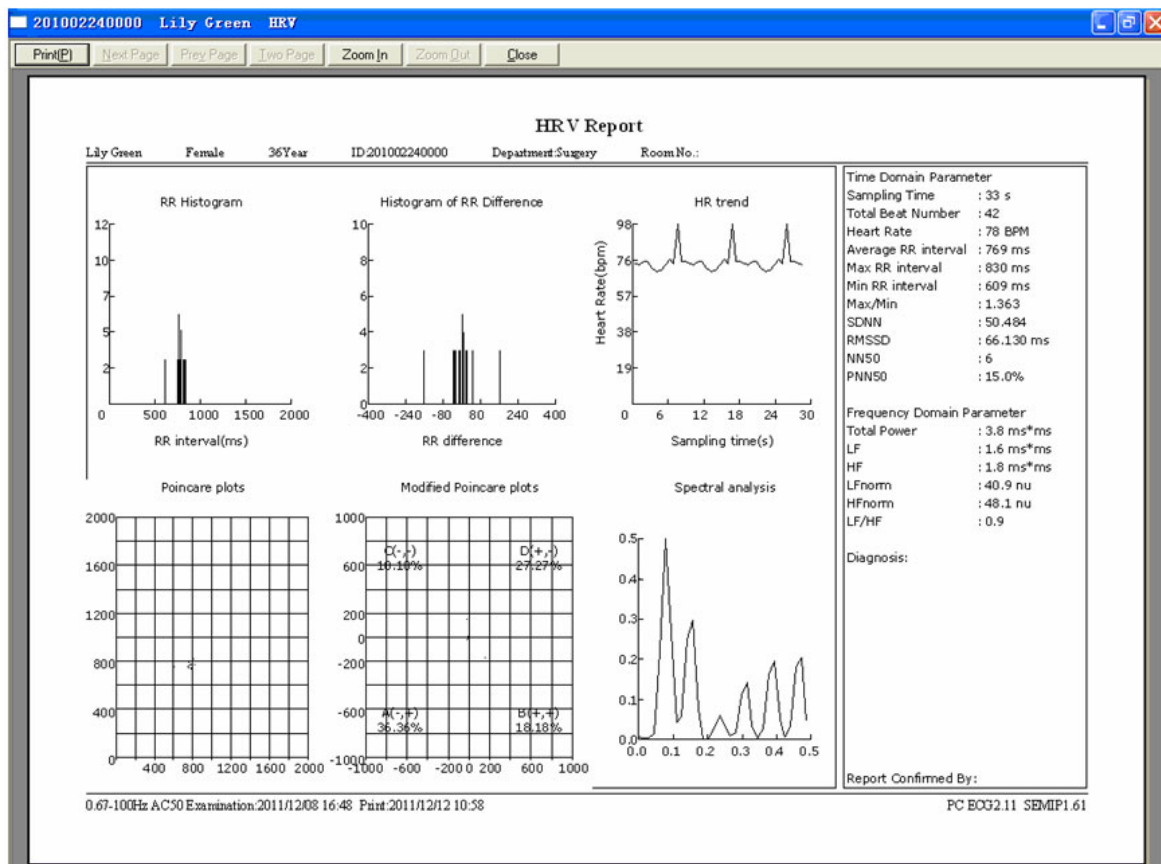
1. You can drag the mouse in the window to choose the wave field to be printed. Then click on the **Print** button to print the selected wave field.
2. Click on **Previous Page** or **Next Page** to display the waves of the previous or next page.

6.6.5.3 Previewing HRV

Click on the **Preview** button to open the HRV preview screen.

 is the toolbar on the HRV preview screen.

1. Click on **Print(P)** to print the report.
2. Click on **Next Page/Prev Page** to switch to the previous/next preview page.
3. Click on **Two Page** to preview two pages on one screen simultaneously.
4. Click on **Zoom In/ Zoom Out** to magnify/minify the preview page.
5. Click on **Close** to close the preview screen and return to the previous screen.



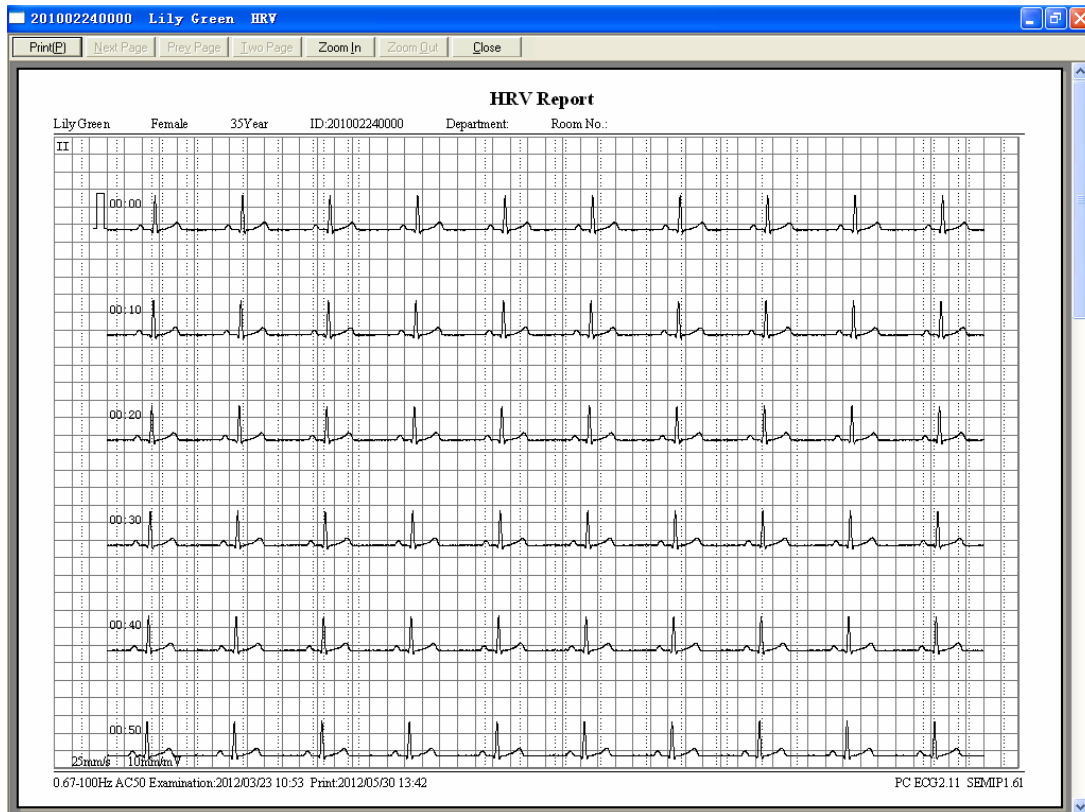
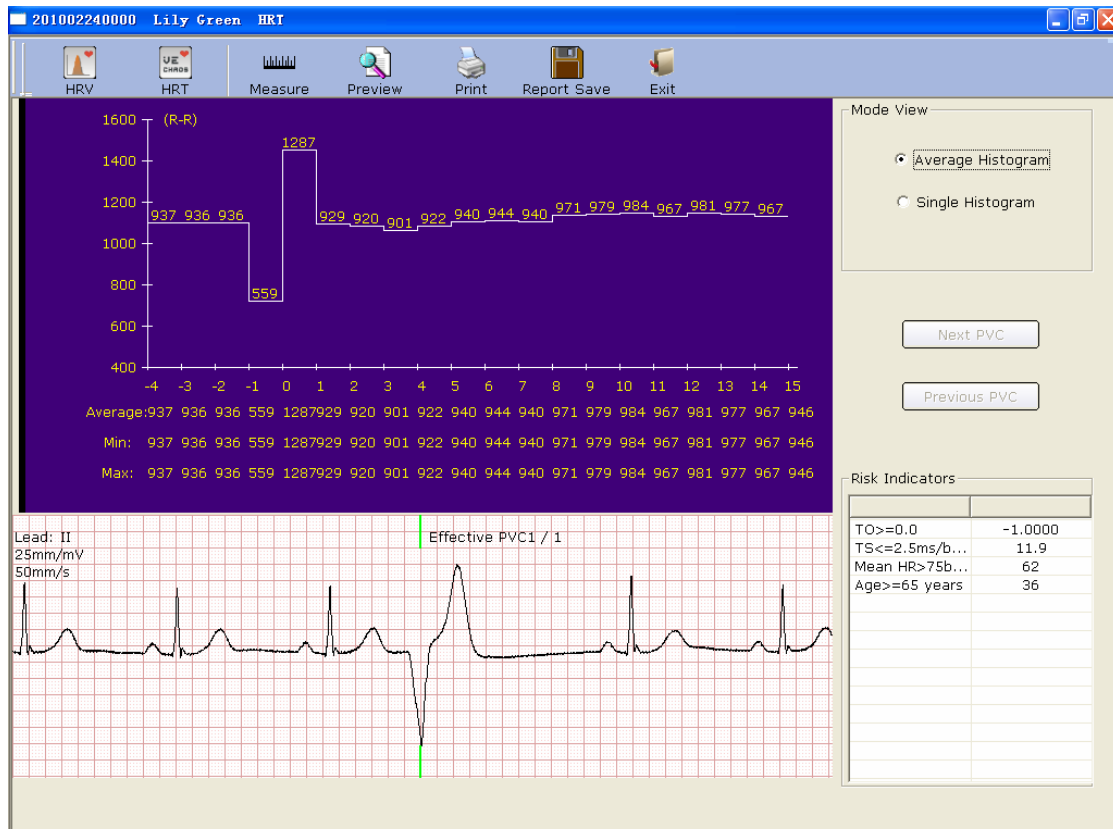


Figure 6-23 HRV Preview Screen

6.6.6 Analyzing HRT

Click on **HRT** to display the HRT ECG analysis screen.



You can select **Average Histogram** or **Single Histogram** in **Mode View** field.

Click on **Next PVC** or **Previous PVC** to see the Next or Previous PVC wave and the relevant histogram.

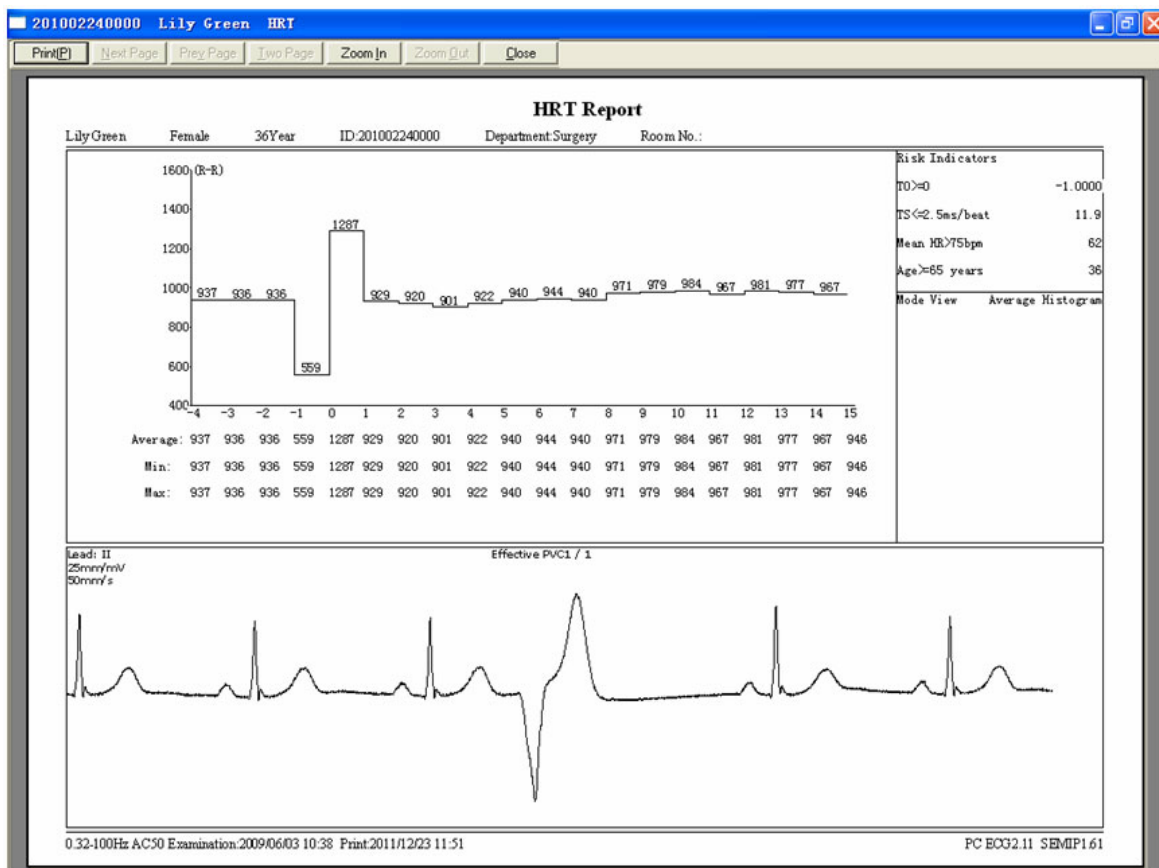
Click on the **Preview** button to open the HRT preview screen.



is the toolbar on the

HRT preview screen.

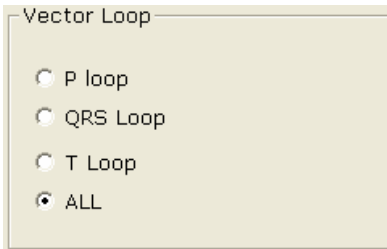
1. Click on **Print(P)** to print the report.
2. Click on **Next Page/Prey Page** to switch to the previous/next preview page.
3. Click on **Two Page** to preview two pages on one screen simultaneously.
4. Click on **Zoom In/ Zoom Out** to magnify/minify the preview page.
5. Click on **Close** to close the preview screen and return to the previous screen.



6.6.7 Analyzing Vector ECG

Click on the **VCG** button on the ECG analysis screen to display the VCG analysis screen. Vector ECG displays 3D image of ECG activity.

You can choose the plane **Frontal(F)** | **Horizontal(H)** | **Sagittal(S)** | **ALL** and the vector loop



on the VCG analysis screen. Plane choices include **Frontal (F)**, **Horizontal (H)**, **Sagittal(S)** and **ALL**. Loop choices include **P loop**, **QRS loop**, **T loop** and **ALL**.

6.6.7.1 Displaying Vector ECG with All Plane and All Loop

Set the plane to **ALL** and the loop to **ALL**.

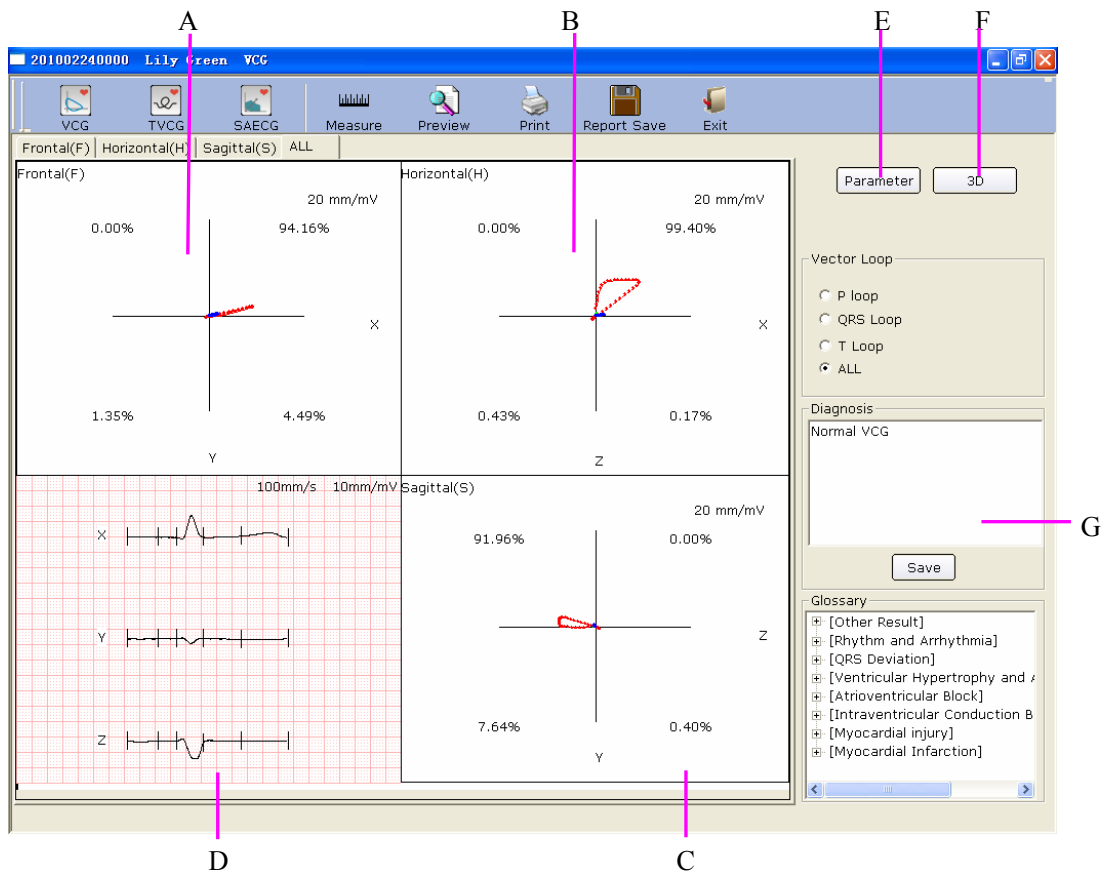


Figure 6-24 Vector ECG - Plane of ALL and Loop of ALL

Figure 6-24 displays Vector ECG with the plane of **ALL** and the loop of **ALL**.

A- Vector ECG of Frontal (F)

B- Vector ECG of Horizontal (H)

C- Vector ECG of Sagittal (S)

D- Average templates of X, Y and Z leads. Double-click on this figure to display the magnified average template. You can drag these lines marked P1, P2, Q, S, T1 and T2 on the wave. With the change of the line position, the corresponding parameter values change.

E- Click on the **Parameter** button to display the following Vector ECG parameter list.

Amp.:mV Ang.:deg		Frontal(F)		Horizontal(H)		Sagittal(S)	
		Ang.	Amp.	Ang.	Amp.	Ang.	Amp.
P	MaxV.30ms	12	0.13	-53	0.20	180	0.16
	Direction	CCW		CCW		CW	
QRS	MaxV.33ms	-3	1.60	-56	2.80	181	2.34
	0.01s	0	0.11	60	0.22	0	0.19
	0.02s	-6	0.61	-13	0.62	204	0.16
	0.03s	-5	1.49	-51	2.38	184	1.87
	0.04s	0	0.96	-64	2.21	179	2.00
	StartV.16ms	0	0.30	37	0.37	0	0.22
	EndV.25ms	172	0.21	240	0.42	176	0.36
	Direction	CW		CCW		CCW	
T	MaxV.74ms	-5	0.42	10	0.42	-34	0.09
	STV.	3	0.05	-41	0.06	177	0.04
	Length/Width	7.27		6.50		3.29	
	T-R angle	-2		66		-215	
	Direction	CCW		CCW		CCW	
	HR	P Dur.		QRS Dur.		T Dur.	
	76 BPM	81 ms		92 ms		187 ms	

Designation	Definition
Max Vector	The position of the maximal amplitude of QRS/P/T loop (mV)
Amplitude	The amplitude of the Max vector of QRS/P/T loop (mV)
Angle	The angle of the Max vector of QRS/P/T loop (degree)
Direction	Rotation direction of QRS/P/T loop
CW	Clockwise
CCW	Counter-clockwise

8	'8' font ring
0.01 (amplitude)	The amplitude at 0.01s from QRS loop
0.01 (angle)	The angle at 0.01s from QRS loop
0.02 (amplitude)	The amplitude at 0.02s from QRS loop
0.02 (angle)	The angle at 0.02s from QRS loop
0.03 (amplitude)	The amplitude at 0.03s from QRS loop
0.03 (angle)	The angle at 0.03s from QRS loop
0.04 (amplitude)	The amplitude at 0.04s from QRS loop
0.04 (angle)	The angle at 0.04s from QRS loop
Start Vector	Start point of QRS loop
End Vector	End point of QRS loop
ST Vector	The position of ST vector in vector loop
Length/Width	The ratio of length to width in T loop
T-R angle	The degree between the Max vector of T loop and the Max vector of QRS loop (degree)

F- Click on **3D** to display the 3D VCG graph.

G- Diagnosis Field

1. Enter your own opinions in the **Auto Diagnosis** textbox, and then click on the **Save** button.
2. Or, double-click on the necessary results required to be added in the **Glossary** textbox, and the selected results will be displayed in the **Auto Diagnosis** textbox, and then click on the **Save** button.

6.6.7.2 Displaying Vector ECG with Frontal Plane and QRS Loop

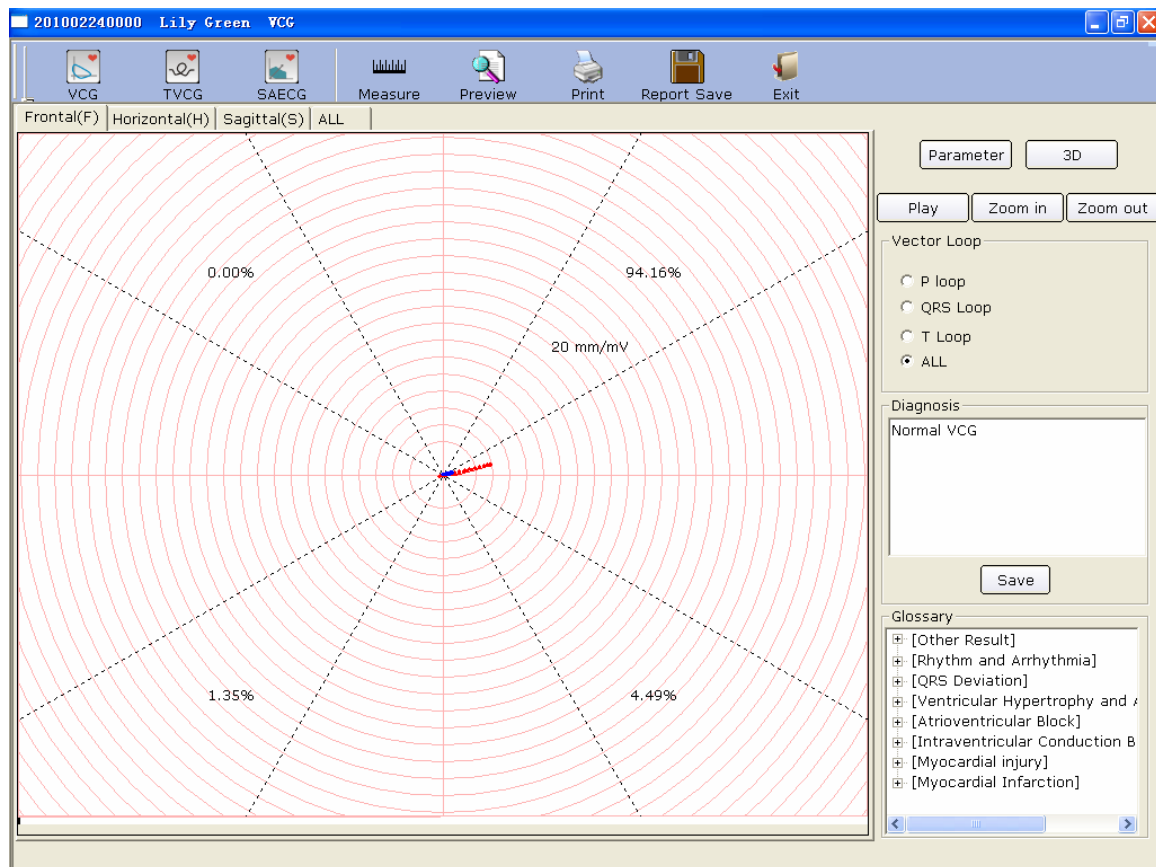


Figure 6-25 Vector ECG - Frontal & QRS loop

The percent values of **0.00%**, **94.16%**, **1.35%** and **4.49%** in the square represent the area percentages of QRS loop in every quadrant. **20 mm/mV** indicates the magnified multiple (gain). The red curve is QRS loop.

You can click on the **Zoom in** button or the **Zoom out** button to change the gain of the displayed graphics. You can click on the **Play** button to watch the forming process of the QRS loop.

6.6.7.3 Displaying 3D Vector ECG

Click on **3D** to display the 3D VCG graph.

3D (Three Dimensional Vector Loops)

This function allows you to observe the Vector ECG in three dimensions.

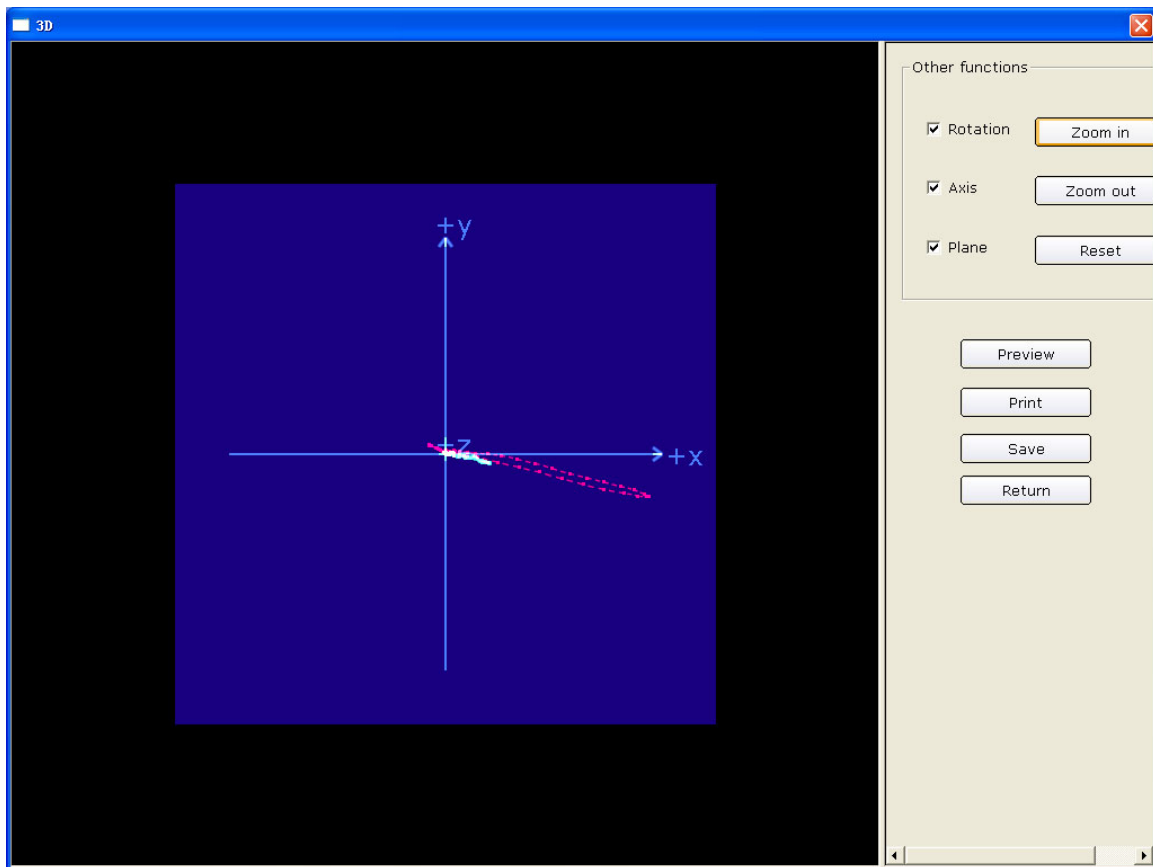
Select **Rotation**, and then you can rotate the whole picture to view all directions of the vector loops by clicking the mouse.

Select **Axis** to display the axes.

Select **Plane** to display the planes.

Click on **Zoom In/ Zoom Out** to magnify/minify the picture.

Click on **Reset** to restore the magnified/minified picture to original size.



Click on **Preview** to preview the 3D graph.

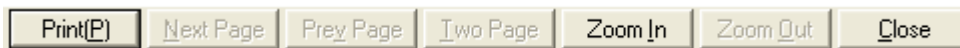
Click on **Print** to print the 3D graph.

Click on **Save** to save the graph on the current screen.

Click on **Return** to return to the ECG analysis screen.

6.6.7.4 Previewing Vector ECG

Click on the **Preview** button to open the VCG preview screen.



is the toolbar on the

VCG preview screen.

1. Click on **Print(P)** to print the report.
2. Click on **Next Page/Prey Page** to switch to the previous/next preview page.
3. Click on **Two Page** to preview two pages on one screen simultaneously.
4. Click on **Zoom In/ Zoom Out** to magnify/minify the preview page.
5. Click on **Close** to close the preview screen and return to the previous screen.

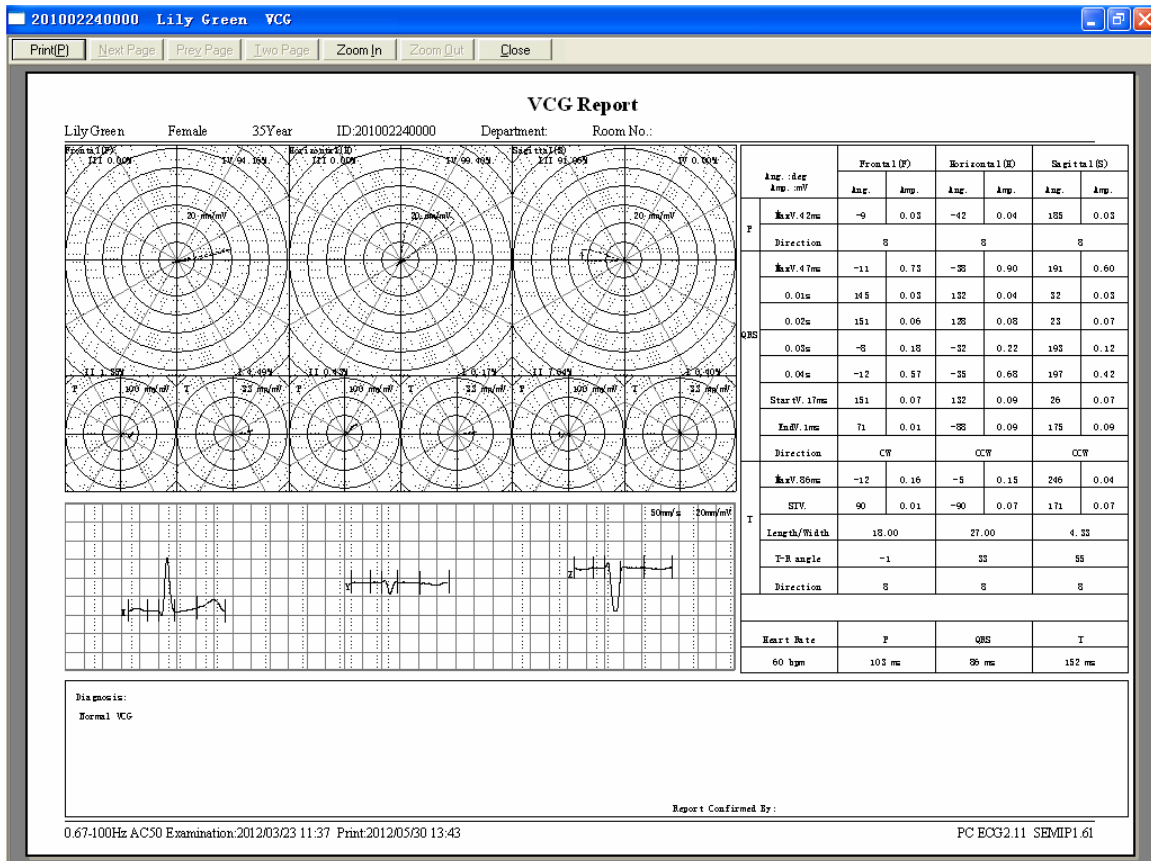
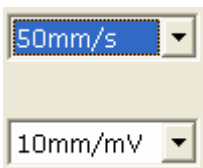


Figure 6-26 VCG Preview Screen (Plane is ALL & loop is ALL)

6.6.8 Analyzing Time Vector ECG

Click on the **TVCG** button on the ECG analysis screen to display the TVCG analysis screen. Time Vector ECG is Vector ECG including time factor.

As Figure 6-27 shows, you can observe waves of X lead, Y lead, Z lead, X-Y lead, X-Z lead and Z-Y lead.



You can choose the speed and the gain of the displayed waves.

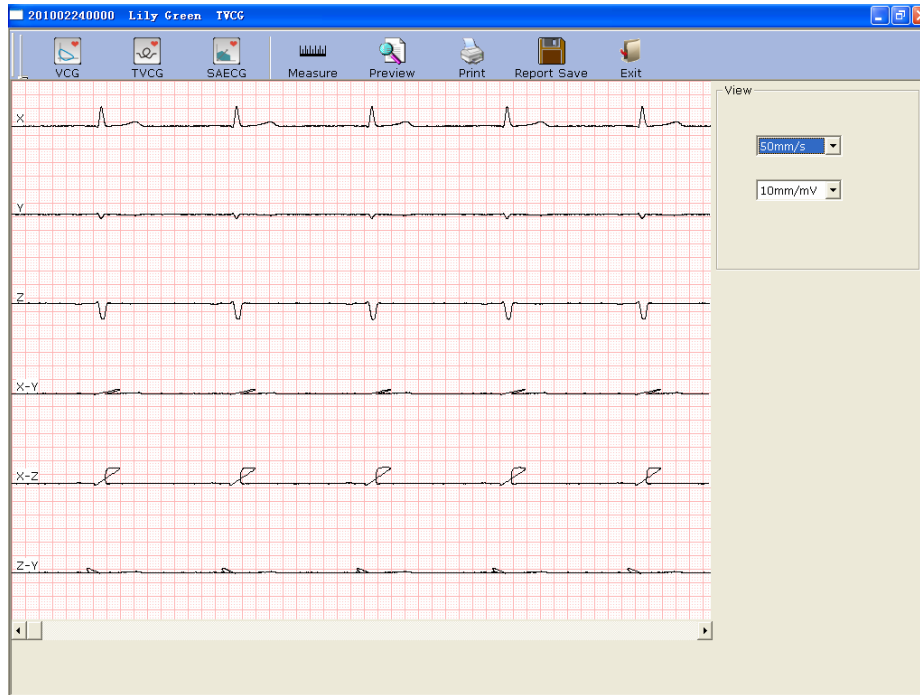
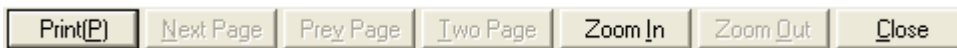


Figure 6-27 Time Vector ECG Screen

Click on the **Preview** button to display the TVCG preview screen.



is the toolbar on the

TVCG preview screen.

1. Click on the **Zoom In** button on the toolbar to magnify the preview page.
2. Click on the **Zoom Out** button on the toolbar to minify the preview page.
3. Click on the **Close** button to close the TVCG preview screen and return to the previous screen.

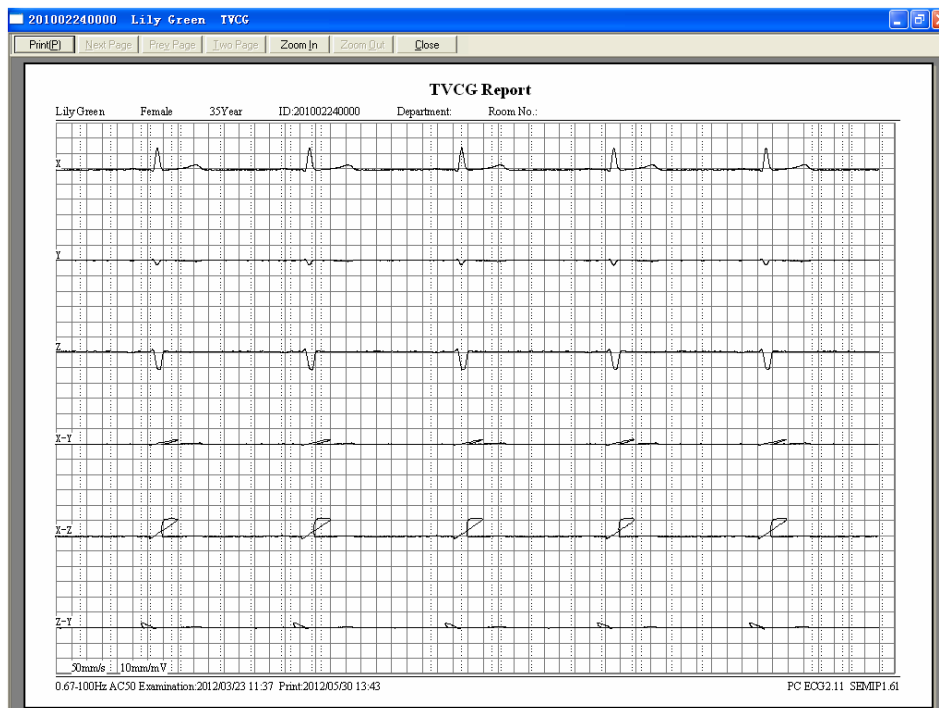


Figure 6-28 Time Vector ECG Preview Screen

6.6.9 Analyzing Signal Averaged ECG

SAECG is also called Ventricular Late Potential (VLP). Click on **SAECG** to open the SAECG analysis screen. The SAECG analysis screen includes two tabs: **Time domain** and **Frequency domain**.

6.6.9.1 About the Time Domain Window

Click on the **Time domain** tab to open the **Time domain** window.

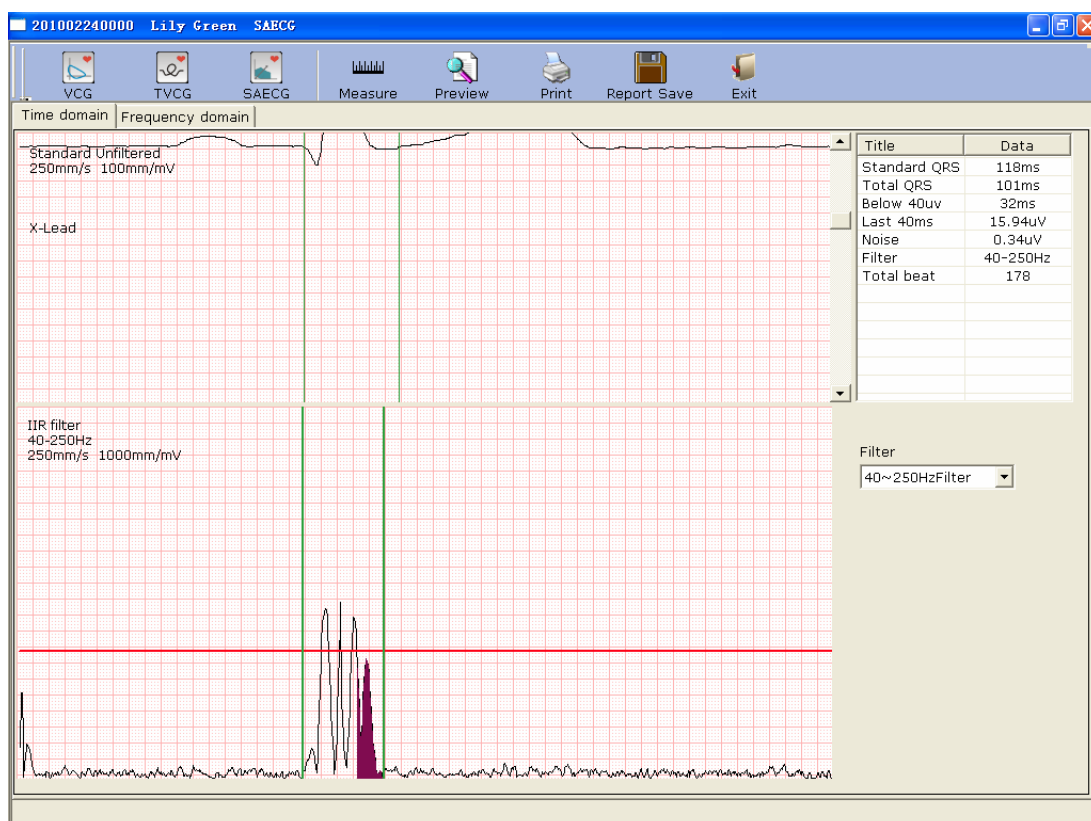
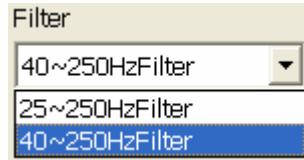


Figure 6-29 Time Domain Window

Every parameter of SAECG is shown in the following table.

Designation	Description
Standard QRS	QRS intervals measured on three-quadrature leads before filtering
Total QRS	The total QRS time for filtering and superimposing QRS waveform.
Below 40 μ V	The time of amplitude that is below 40 μ V for filtering and superimposing QRS waveform.
Last 40 μ V	The root mean square of amplitude in the last 40ms for filtering and superimposing QRS waveform.



Select a filter in the **Filter** pull-down list

The top of the **Time domain** window is the window of standard superimposed QRS waveform. The left green line is the starting point of standard unfiltered QRS waveform, and the right green line is the end point. You can respectively drag the two green lines to change QRS duration.

The bottom of the **Time domain** window is the window of standard superimposed QRS waveform after filtering. The left green line is the starting point of standard filtered QRS waveform, and the right green line is the end point. You can respectively drag the two green lines to change QRS duration, and then the corresponding parameters in the right part will also change.

6.6.9.2 About the Frequency Domain Window

Click on the **Frequency domain** tab to open the **Frequency domain** window.

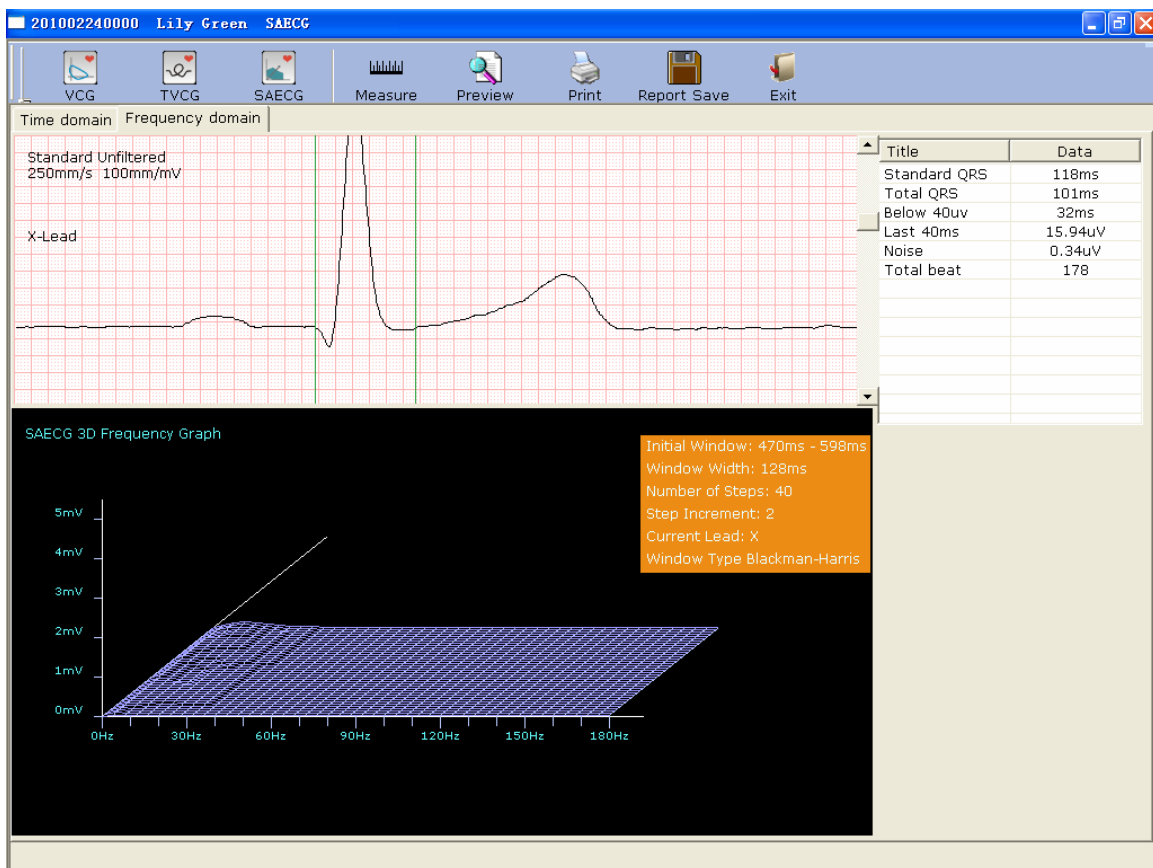
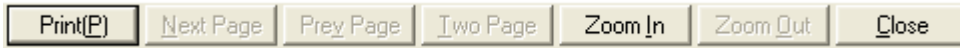


Figure 6-30 Frequency Domain Window

You can drag the green vertical lines on the ECG wave, and the corresponding parameters in the right part and the 3D graph in the bottom part will change.

6.6.9.3 Previewing Signal Averaged ECG

Click on the **Preview** button to display the SAECG preview screen.



is the toolbar on the

SAECG preview screen.

1. Click on **Print(P)** to print the report.
2. Click on **Next Page/Prey Page** to switch to the previous/next preview page.
3. Click on **Two Page** to preview two pages on one screen simultaneously.
4. Click on **Zoom In/ Zoom Out** to magnify/minify the preview page.
5. Click on **Close** to close the preview screen and return to the previous screen.

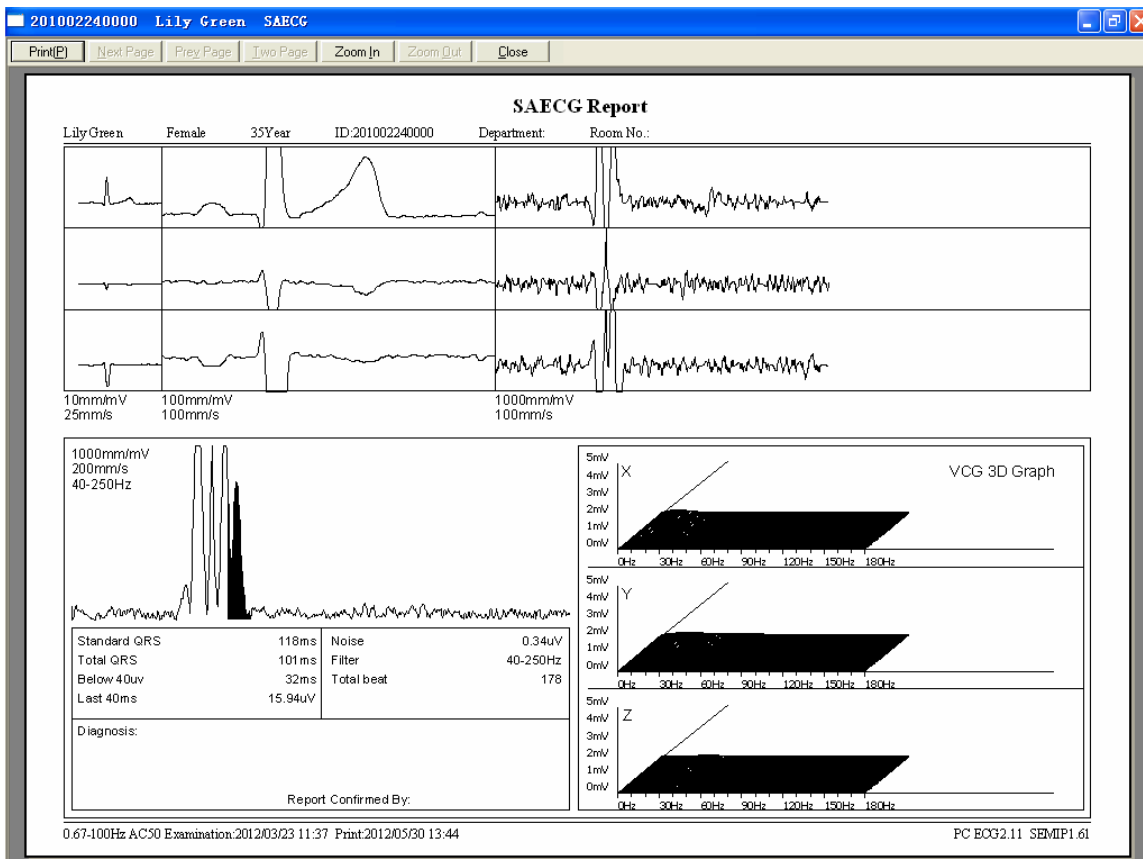
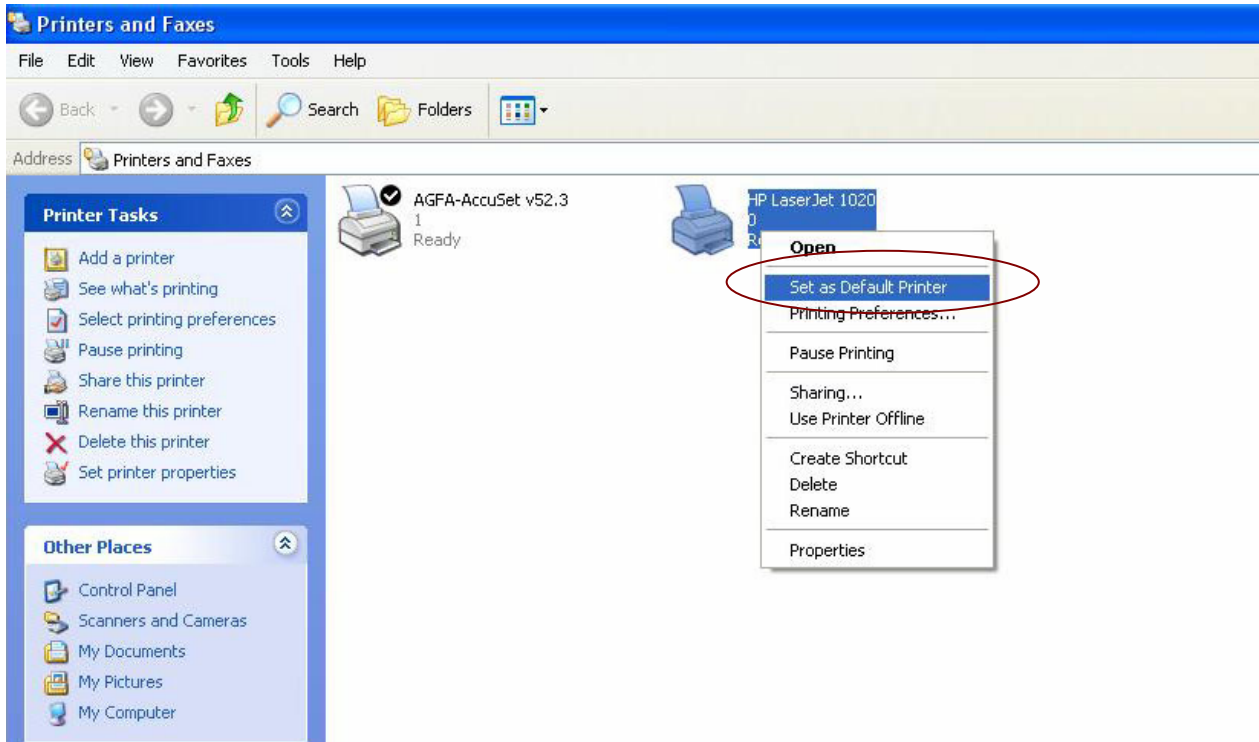


Figure 6-31 Signal Averaged ECG Report

6.6.10 Printing ECG Reports

1. Choose **Start > Printers and Faxes**, and then right-click on the icon of the printer used, and select **Set as Default Printer**. Then close the **Printers and Faxes** window.



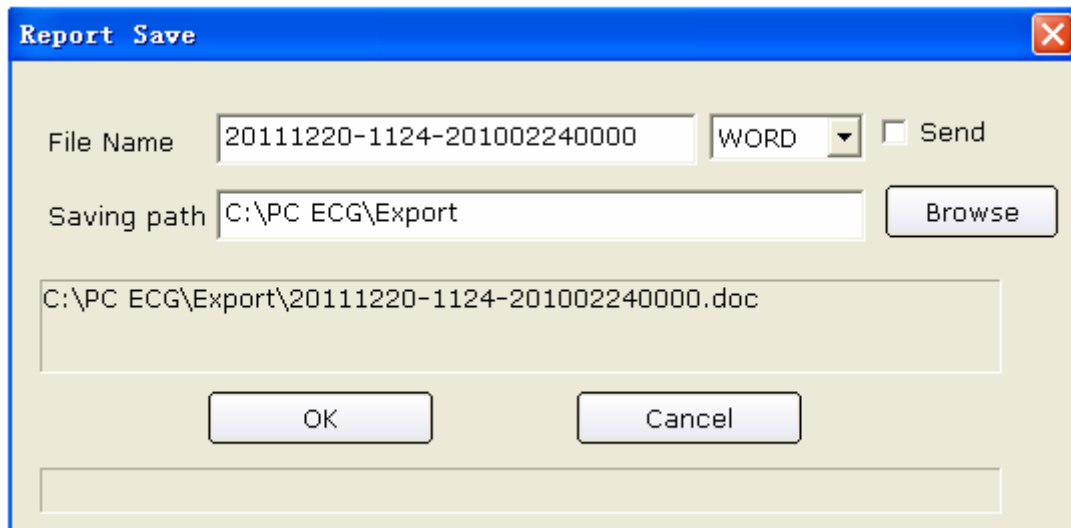
2. Click on the **Print** button on the analysis screen to print an ECG report.
3. Or, click on the **Print** button on the preview screen to print an ECG report.

6.6.11 Saving ECG Reports



You can click on the **Report Save** button  to save ECG reports.

The report format includes **PDF**, **WORD**, **JPG** and **BMP**. Click on the **Browse** button to choose the save path and click on **OK** to save the sampled data to the designated directory. During the saving course, the system will give the hint information.



If you select **Send**, the sampled data will be sent by OUTLOOK EXPRESS (Windows XP) or Window Live Mail (Windows 7/Vista) when it is saved to the designated directory. During the saving and sending course, the system will give the hint information.

NOTE: In Windows 7/Vista, only if Window Live Mail is installed, can the report be sent by email.

6.7 Sampling STAT ECG

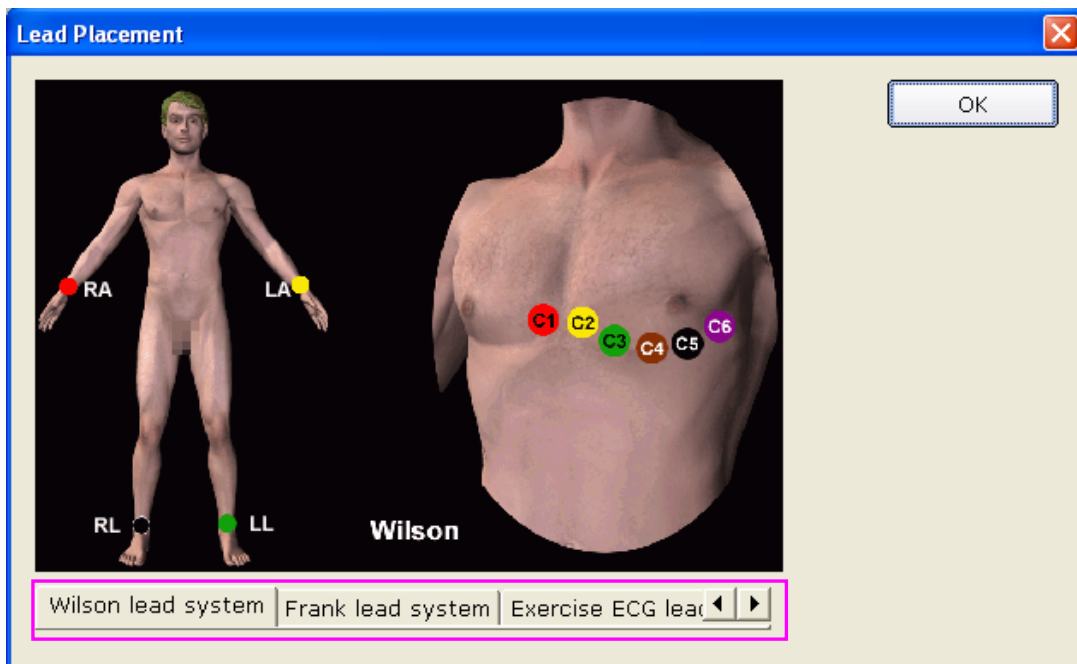
Click on the **STAT ECG** button on the main screen (Figure 6-1) to sample normal ECG directly without entering new patient information or selecting an existing patient record from the database before sampling. The system will automatically distribute a new patient ID.

Chapter 7 Operation Instructions for Exercise ECG

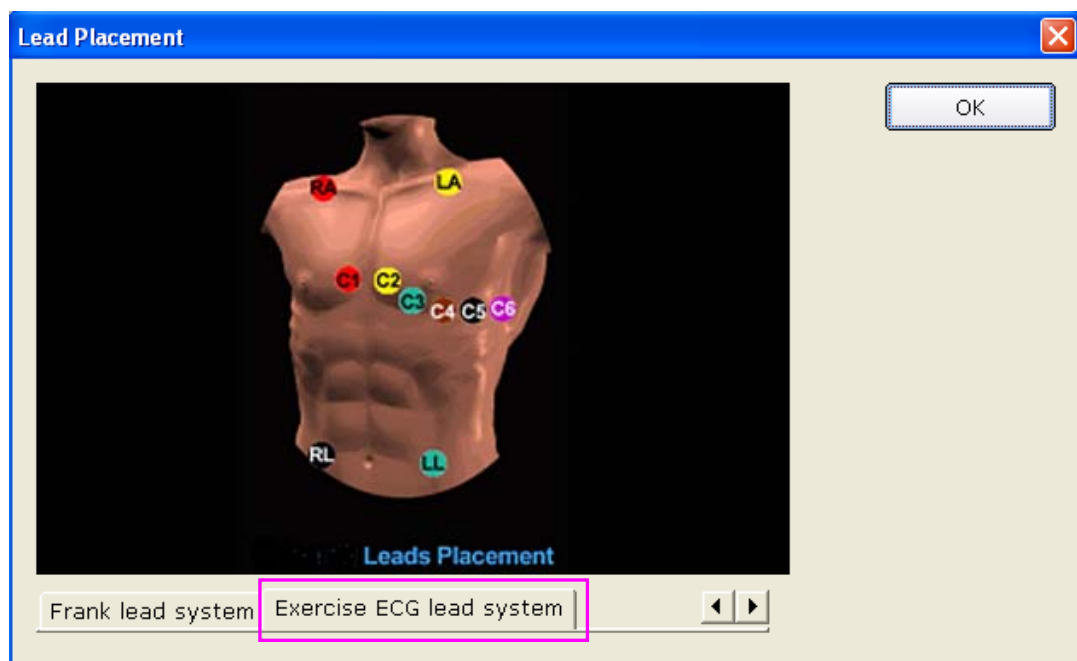
The exercise ECG function is optional. It is available only if you purchased this function.

7.1 Viewing Lead Placement Information

1. Click on the **Lead Placement** button on the main screen to display the **Lead Placement** window.

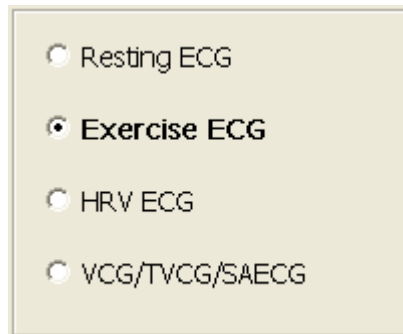


2. Click on **Exercise ECG lead system** to view the lead placement information.



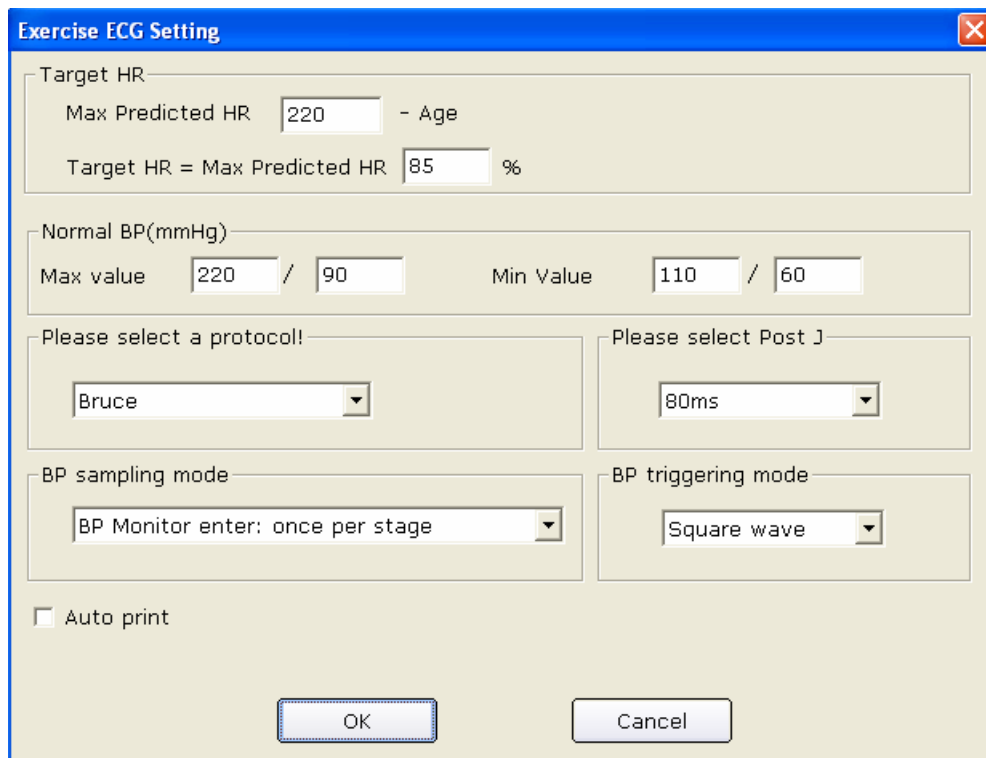
7.2 Selecting a Patient Record to Start a New Test

1. You can select a patient record from the database to start a new test. The operation steps are the same as those of resting ECG. For details, refer to Section 6.2, “Selecting a Patient Record to Start a New Test”.
2. Select **Exercise ECG** in the **Patient Information** window.



A screenshot of a dialog box with a light beige background. It contains four radio button options arranged vertically. The second option, "Exercise ECG", is selected and bolded. The other options are "Resting ECG", "HRV ECG", and "VCG/TVCG/SAECG".

3. Click on **OK** in the **Patient Information** window to open the **Exercise ECG Setting** window. After setting the parameters, click on the **OK** button to open the pre-sampling screen.

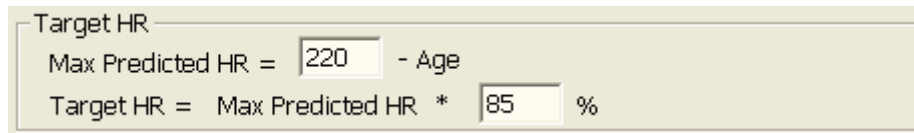


A screenshot of the "Exercise ECG Setting" dialog box. The title bar is blue with a close button (X) on the right. The dialog has a light beige background and contains the following fields and controls:

- Target HR:** Max Predicted HR: - Age; Target HR = Max Predicted HR: %
- Normal BP(mmHg):** Max value: / ; Min Value: /
- Please select a protocol:** (dropdown)
- Please select Post J:** (dropdown)
- BP sampling mode:** (dropdown)
- BP triggering mode:** (dropdown)
- Auto print
- Buttons: and

7.2.1 Setting Target HR

The system applies the following formulas to calculate the target heart rate.



Target HR

Max Predicted HR = - Age

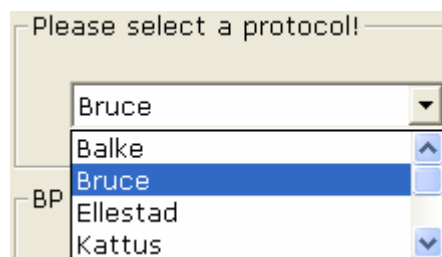
Target HR = Max Predicted HR * %

220 and **85** are default values, and you can modify them in different situations in the **Exercise ECG Setting** window.

7.2.2 Setting Normal BP

Set the normal BP range in the **Exercise ECG Setting** window. When the patient's BP exceeds the normal BP range, the system will consider it as abnormal status.

7.2.3 Setting a Protocol



Please select a protocol!

Bruce

Balke

Bruce

Ellestad

Kattus

BP

BP

Select a protocol from the pull-down list

7.2.4 Setting Post J

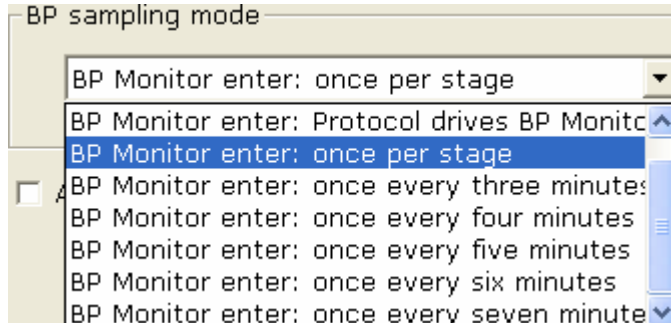
Select a Post J value from the Post J pull-down list in the **Exercise ECG Setting** window.

Post J is the length after J point of the ST segment. You can set Post J to **0ms**, **20ms**, **40ms**, **60ms** or **80ms**.

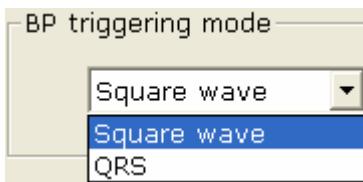
NOTE: J Point is the connection point between the end of QRS complex and the start of ST segment. It is the standard point to fix the position of ST segment in this system. Please select the proper option based on the patient's actual ECG waves.

7.2.5 Setting BP Sampling Mode

Select a BP sampling mode from the **BP sampling mode** list.



7.2.6 Setting BP Triggering Mode



You can set the BP triggering mode to **Square wave** or **QRS** in the **Exercise ECG Setting** window.


7.2.7 Setting Auto Printing

Select **Auto print** to print ECG reports automatically.

7.3 Entering New Patient Information

If the patient is a new one,



1. Click on the **New Patient** button  on the main screen (Figure 6-1) to display the **Patient Information** window, and then enter the patient information. The operation steps are the same as those of resting ECG. For details, refer to Section 6.3, “Entering New Patient Information”.

NOTE:

- 1) Patient ID and age must be entered.
- 2) Please enter the correct patient age which has direct relationship with the calculation of the target heart rate.

2. Select **Exercise ECG** in the **Patient information** window.
3. Click on **OK** in the **Patient information** window to open the **Exercise ECG Setting** window. After setting the parameters, click on the **OK** button to open the pre-sampling screen. For details, please refer to Section 7.2, “Selecting a Patient Record to Start a New Test”.

7.4 Pre-sampling ECG

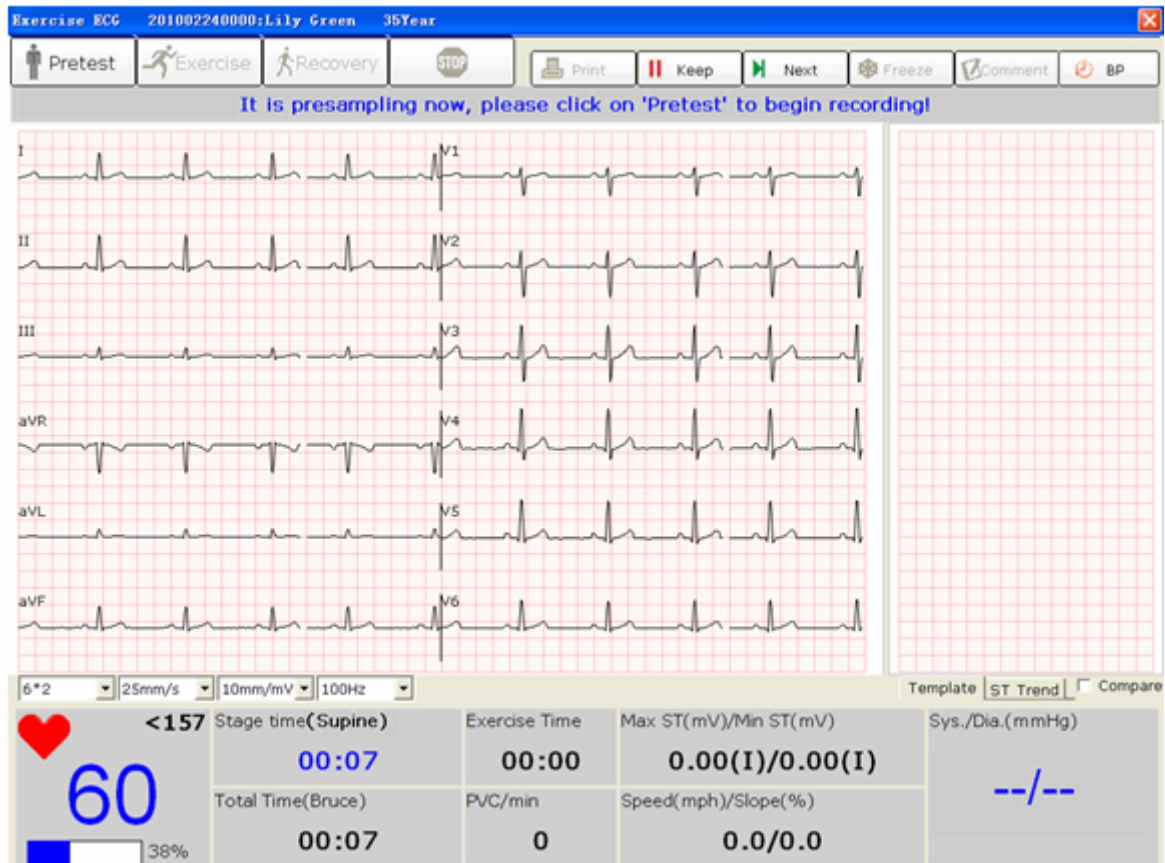
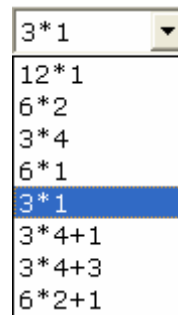
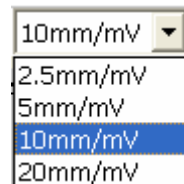


Figure 7-1 Pre-Sampling Screen

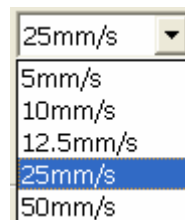
Click on **Pretest/Exercise/Recovery** to enter the relevant phase.



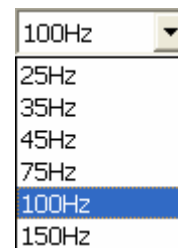
1. Select a display mode from the display mode pull-down list



2. Select a gain from the gain pull-down list



3. Select a speed from the speed pull-down list



4. Select a lowpass filter from the lowpass filter pull-down list

7.5 Pretest Phase

Click on **Print** to print the wave of 10 seconds before you click on **Print**.

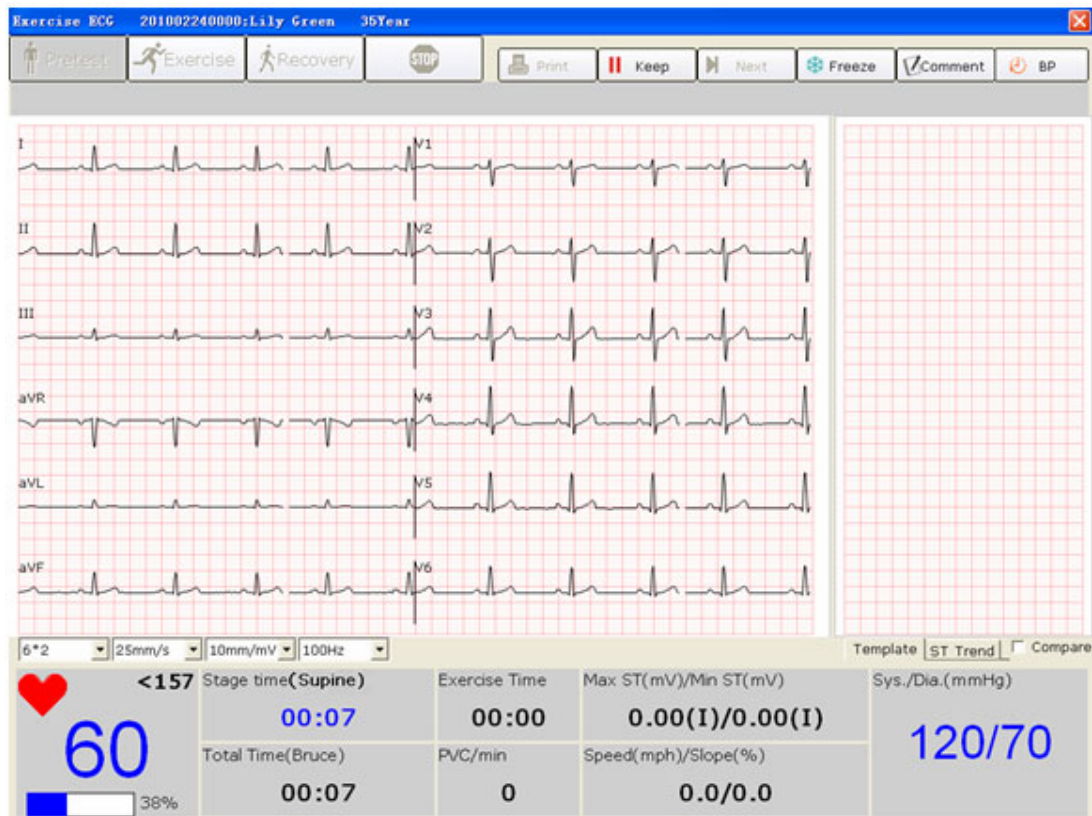
Click on **Keep**, the system will keep staying in the current phase, and the current speed and slope will also be kept until you click on **Keep** again.

Click on **Next**, the system will enter next phase/stage.

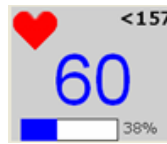
NOTE:

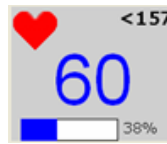
1. If the test time exceeds 40 minutes, the system will enter the monitoring status. Data will not be saved, analyzed or printed any more.
2. The length of the pretest phase is not fixed, but it should be no less than 15 seconds.
3. The pretest phase report will be printed at the fourteenth second.


When the tracings are satisfying and you have specified the desired settings, you can start the pretest.



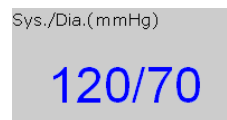
7.5.1 Viewing the Heart Rate and the Blood Pressure

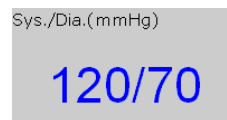


1. View the heart rate in the heart rate field . The middle number is the current heart rate, and the right number is the target heart rate.

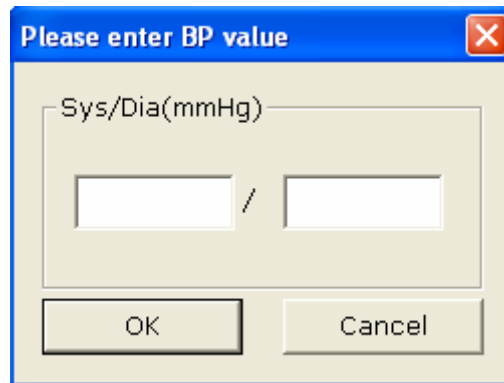
The symbol  shows the percentage of the current heart rate to the target heart rate, and the blue part indicates the current heart rate.

NOTE: If the current heart rate exceeds the target heart rate, the hint *The current HR has exceeded the target HR!* will appear on the sampling screen and the background color of the heart rate field will change from white to yellow.



2. View the blood pressure in the BP field . The left number is the systolic pressure, and the right number is the diastolic pressure. The displayed blood pressure will be updated every set time period. Clicking on the **BP** button can update the displayed blood pressure manually.

Double-click on the BP field on the ECG sampling screen to open the following dialog box, and then enter the blood pressure manually. If you set the BP sampling mode to **Manually Enter BP** in the **Exercise ECG Setting** window, clicking on the **BP** button can also open the following dialog box.



NOTE: If the systolic pressure or the diastolic pressure exceeds the normal BP range, the hint *The systolic/diastolic BP has exceeded the normal range!* will appear on the sampling screen and the background color of the BP field will change from white to yellow.

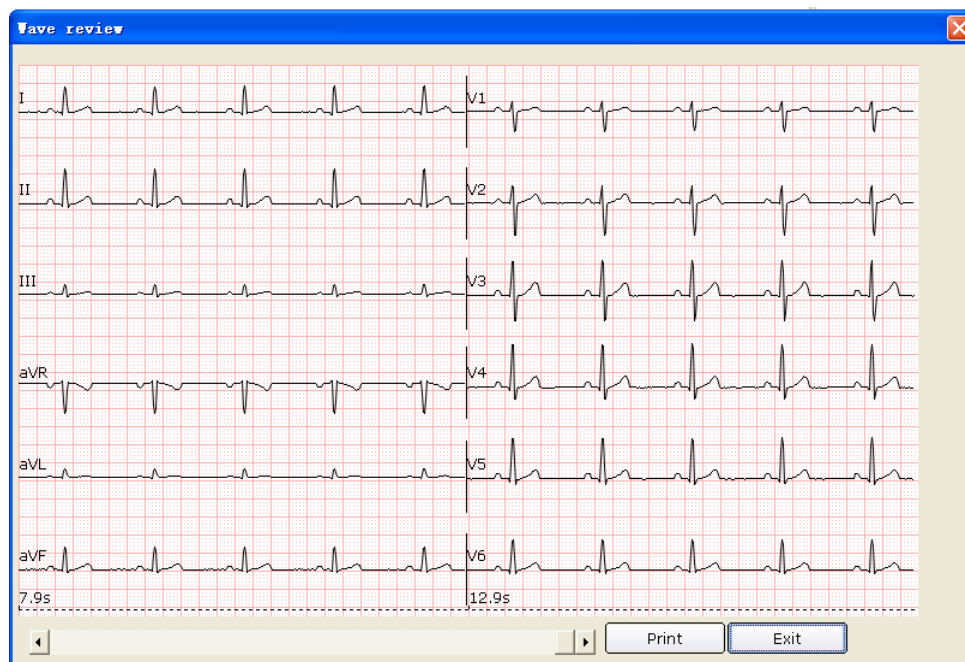
7.5.2 Viewing Other Information

1. If a treadmill is used, view other information such as the stage time, exercise time, total time, PVC/min, speed/slope, and Max ST/Min ST.
2. If an ergometer is used, view other information such as the stage time, exercise time, total time, power/RPM, and Max ST/Min ST.

NOTE: Total time is counted from the beginning of the pretest phase to the end of the exercise test.

7.5.3 Editing the Waveform

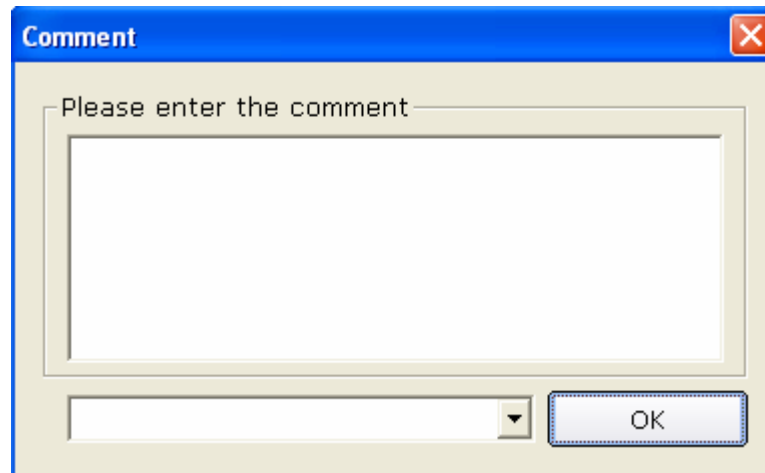
1. Click on the **Freeze** button to freeze waves on the current screen, and the **Wave review** window pops up.



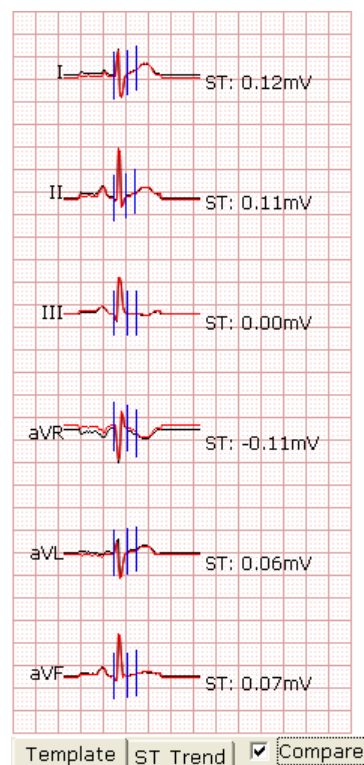
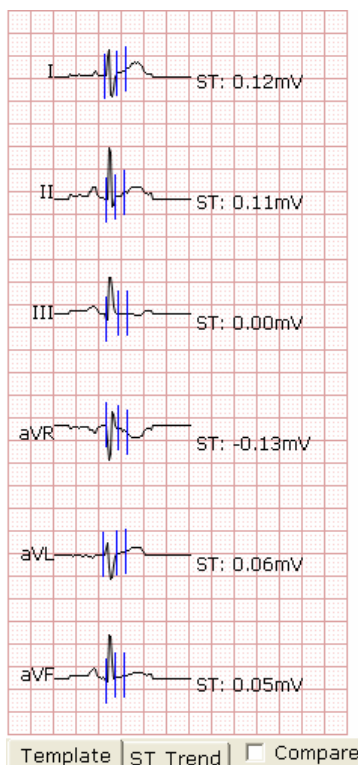
Click on the **Print** button to print the current waveform.

Click on **Exit** to return to the ECG sampling screen.

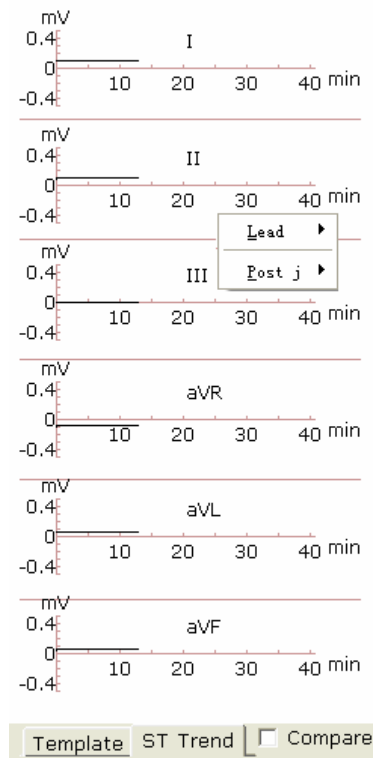
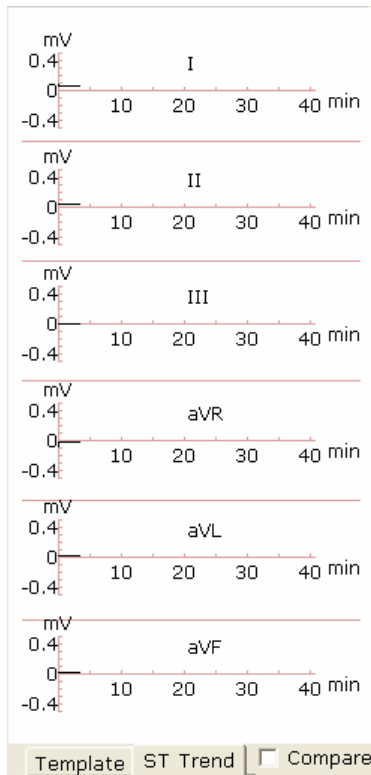
- Click on the **Comment** button to display the **Comment** dialog box. Enter the comment in the **Comment** dialog box. Click on the **OK** button, and the comment will be displayed on the ECG waves on the analysis screen.



- Click on the **Template** button, and the average waves of 12 leads and the calibration lines will be displayed. The average waves will be updated every 10 seconds. Right-click on the average wave field to display the lead group menu, and then you can select other leads. Select **Compare** to compare the current ST segments with the average beats of the sampled data in the first stage of the pretest phase. Double-click on the average wave of a lead, the amplified average wave of the lead and the calibration lines will be displayed. You can drag the calibration lines on the wave. The average wave will be updated every 10 seconds.



- Click on the **ST Trend** button to display the ST trend. Right-click on the ST trend field to display the lead group menu, and then you can select other leads.



7.5.4 Printing the Pretest Report

- The pretest report will be printed automatically 14 seconds after the beginning of the pretest phase.
- Or, you can click on the **Print** button to print the pretest report.

7.6 Exercise Phase

- Instruct the patient to use the treadmill/ergometer. Then click on the **Exercise** button to enter the exercise phase. Or, the system will enter the exercise phase automatically after reaching the set pretest time.
- View the heart rate and BP of the patient. For details, please refer to Section 7.5.1, “Viewing the Heart Rate and the Blood Pressure”.

NOTE: When the current heart rate exceeds the target heart rate, click on the **Recovery** button to enter the recovery phase and observe the waveforms.

- View other information. For details, please refer to Section 7.5.2, “Viewing Other Information”.
- Edit the waveform. For details, please refer to Section 7.5.3, “Editing the Waveform”.
- Click on the **Print** button to print the exercise report.
- The system will enter the next stage of the exercise phase automatically after the set time of this stage is over. Or, click on the **Exercise** or **Next** button to enter the next stage of the exercise phase manually.

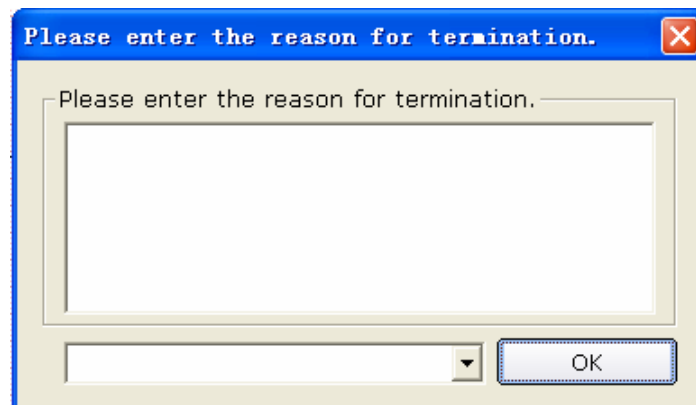
7. Click on the **Keep** button and the system enters the **Keep** state. The hint *Keep* will be displayed in the speed/power field. The **Next** button becomes unavailable. In this state, the system will not follow the previous settings to change the speed and grade of the treadmill, but keep the current speed and grade until this button is pressed again.

7.7 Recovery Phase

1. When the current heart rate exceeds the target heart rate, click on the **Recovery** button to enter the recovery phase. Or, the system will enter the recovery phase automatically after the set exercise test time is over.
2. View the heart rate and BP of the patient. For details, please refer to Section 7.5.1, “Viewing the Heart Rate and the Blood Pressure”.
3. View other information. For details, please refer to Section 7.5.2, “Viewing Other Information”.
4. Edit the waveform. For details, please refer to Section 7.5.3, “Editing the Waveform”.
5. Click on the **Print** button to print the recovery report.
6. The system will enter the next stage of the recovery phase automatically after the set time of this stage is over. Or, click on the **Recovery** button or click on the **Next** button to enter the next stage of the recovery phase manually.

7.8 Exiting the Exercise Test

During the exercise test, click on the **STOP** button to display the following dialog box. Enter the reasons for termination in the dialog box or select a reason from the pull-down list. Then click on the **OK** button to open the analysis screen. The reason for termination will be displayed in the summary report.



7.9 About Analysis Screen

7.9.1 About Summary Screen

1. Click on **Summary** to open the **Summary** screen.

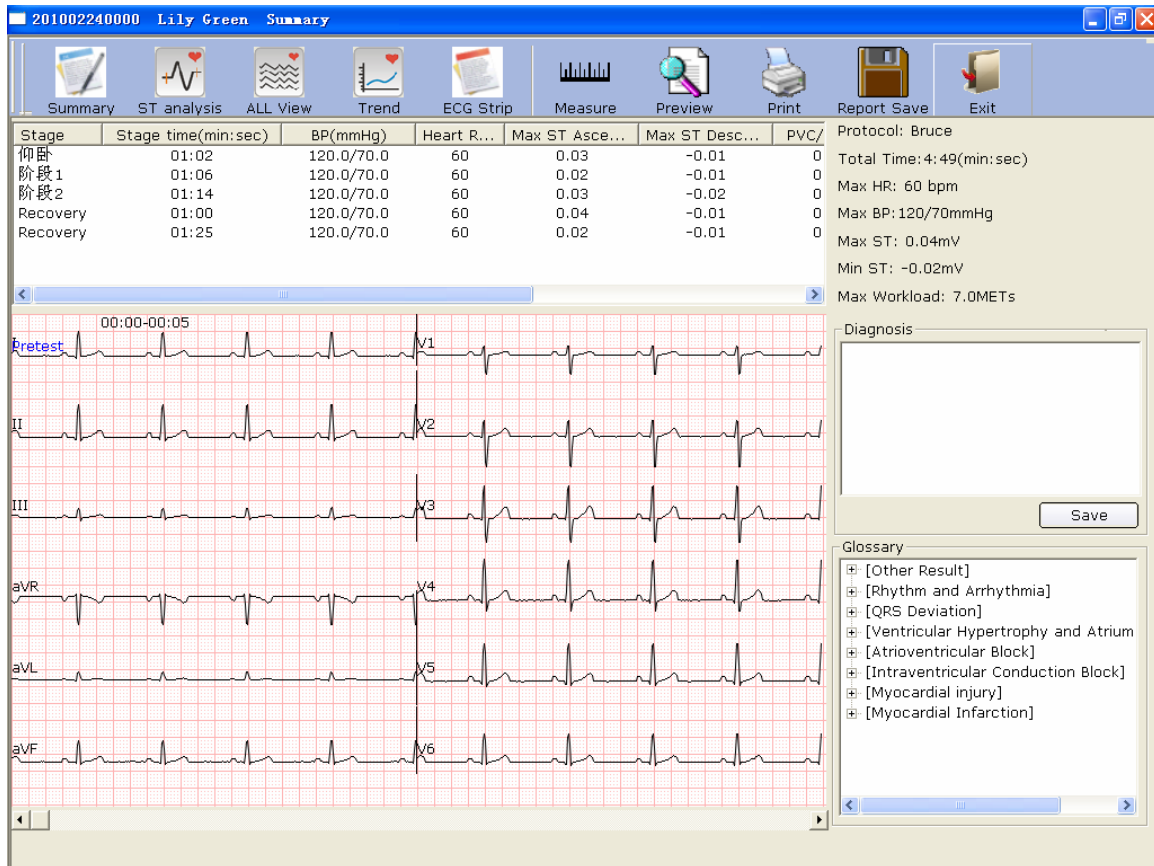


Figure 7-2 Summary Screen

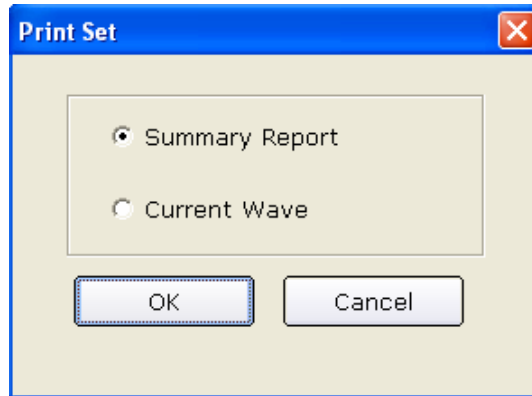
Click on the **Measure** button, click on one point on the wave, and then drag the mouse to another point. The distance, amplitude difference and heart rate between the two points will be displayed.

2. If a treadmill is used, view the stage, stage time, speed, slope, workload (METs), BP, HR, PVC, Max ST and Min ST in every stage of the exercise test in the list.

If an ergometer is used, view the stage, stage time, power, BP, HR, PVC, Max ST and Min ST in every stage of the exercise test in the list.

3. Double-click on a stage, the scroll bar of the wave field will be scrolled to the ECG waves of the stage.
4. Right-click on a wave, and then click on the pop-up **Add Comment** menu. Then you can enter the comment in the **Comment** dialog box. Click on the **OK** button, and the comment will be displayed on the wave. Right-click on the comment, and then you can click on the **Delete Comment** button to delete the comment.

5. Enter diagnosis results in the **Diagnosis** textbox, and then click on **Save**.
6. Or, double-click on the necessary results required to be added in the **Glossary** textbox, the selected results will be displayed in the **Diagnosis** textbox, and then click on the **Save** button.
7. Click on the **Preview** button to display the **Print Set** window.



Select **Summary Report** or **Current Wave**. Click on the **OK** button to open the preview screen.

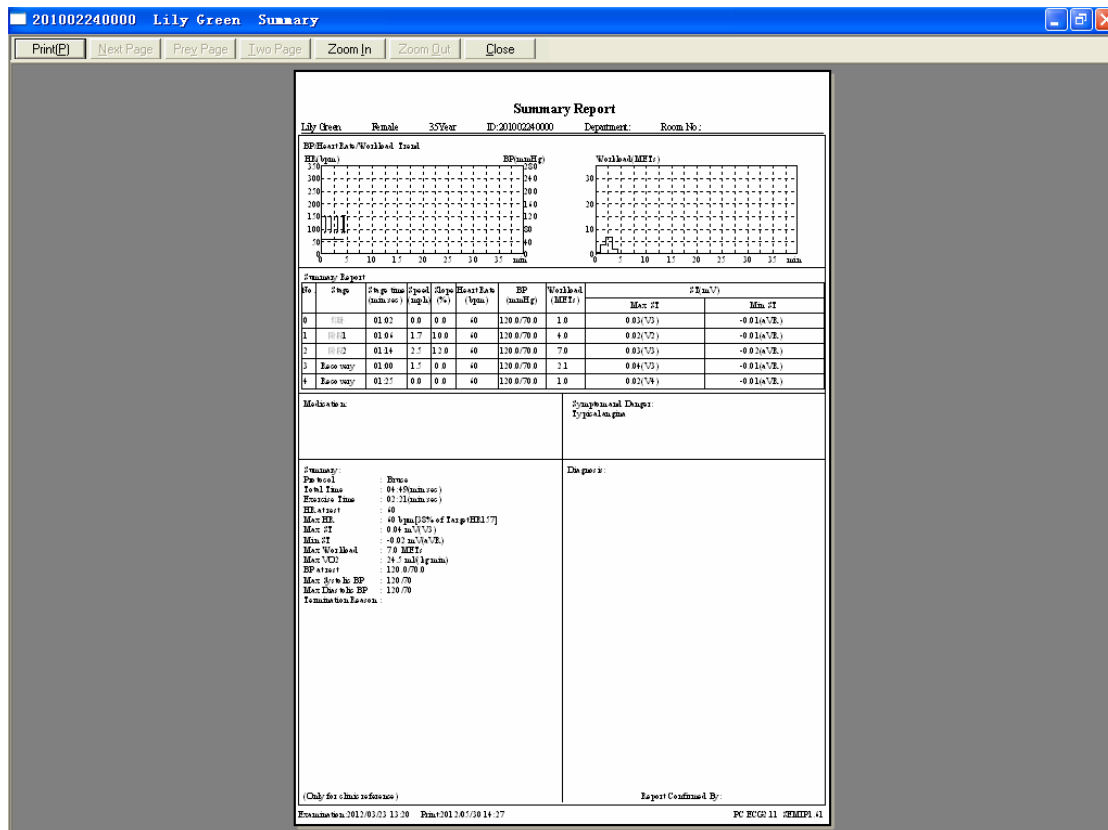


Figure 7-3 Summary Report

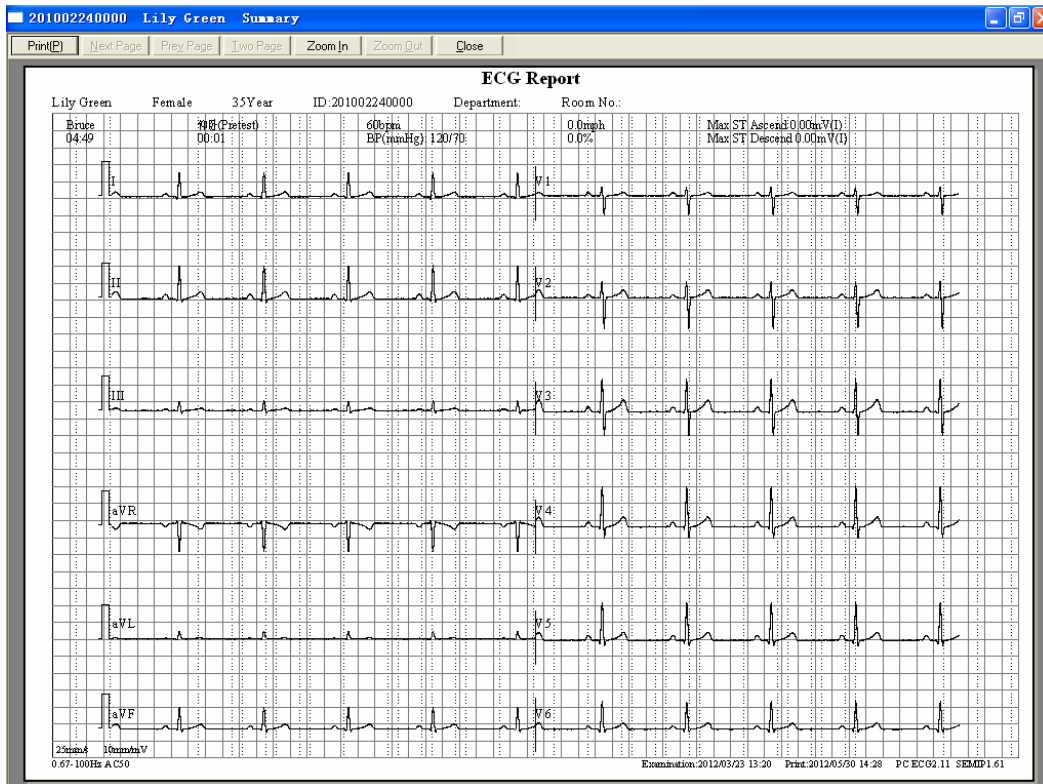


Figure 7-4 Current Wave Report

NOTE: The diagnosis result is displayed in the diagnosis field of the summary report.

7.9.2 About ST Analysis Screen

1. Click on the **ST analysis** button to display the **ST analysis** screen.

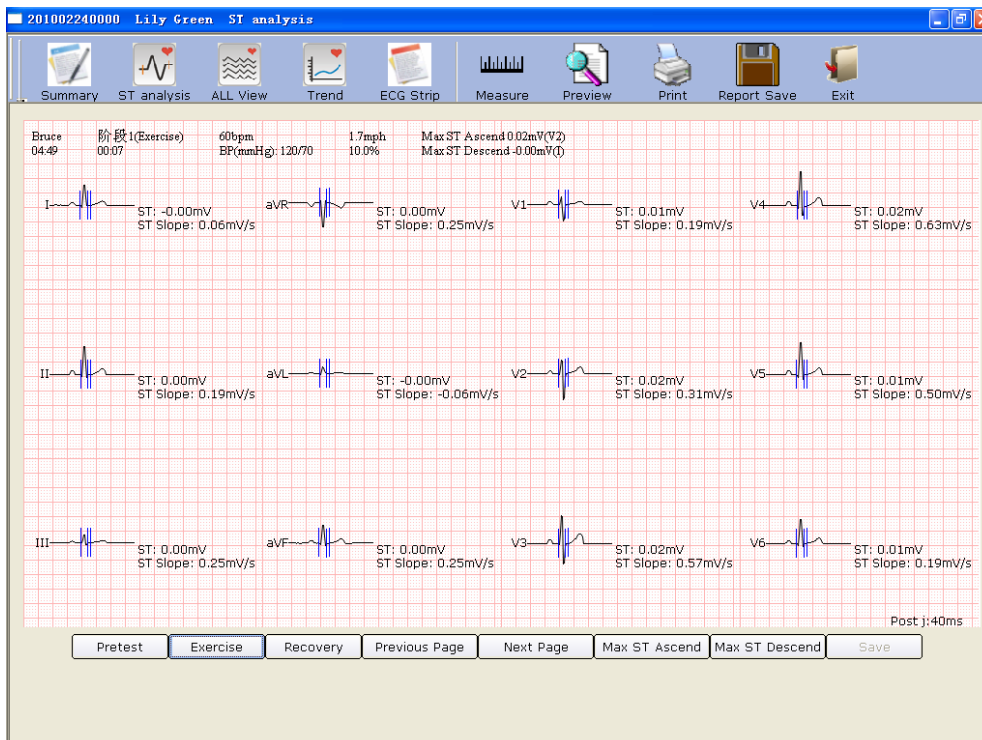
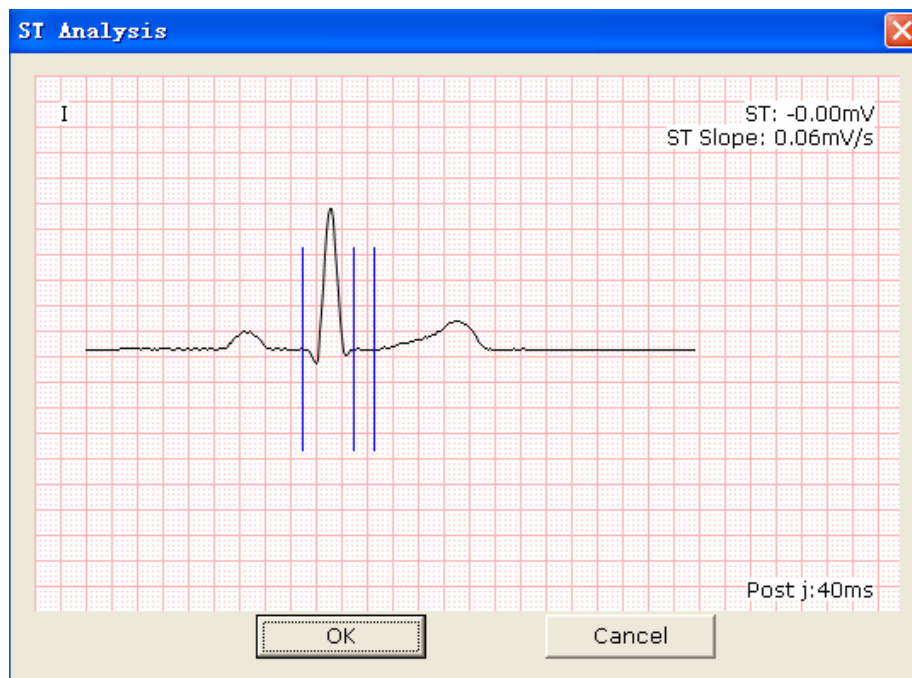


Figure 7-5 ST Analysis Screen

2. Click on **Pretest** to display 12-lead ST analysis waves of the pretest phase.
3. Click on **Exercise** to display 12-lead ST analysis waves of the exercise phase.
4. Click on **Recovery** to display 12-lead ST analysis waves of the recovery phase.
5. Click on **Previous Page/Next Page** to display 12-lead ST analysis waves of every 10 seconds.
6. Click on **Max ST Ascend** to display the Max ST ascending waves.
7. Click on **Max ST Descend** to display the Max ST descending waves.
8. You can double-click on the wave to select the PostJ value on the **ST analysis** screen. Double-click on the wave of a lead, the amplified wave of the lead and the calibration lines will be displayed. Drag the calibration lines on the wave, and then the ST value will change. Click on the **OK** button, and then the **Save** button becomes available. Click on **Save** to save the modifications.



7.9.3 About All View Review Screen

1. Click on the **ALL View** button to display the **ALL View** screen.

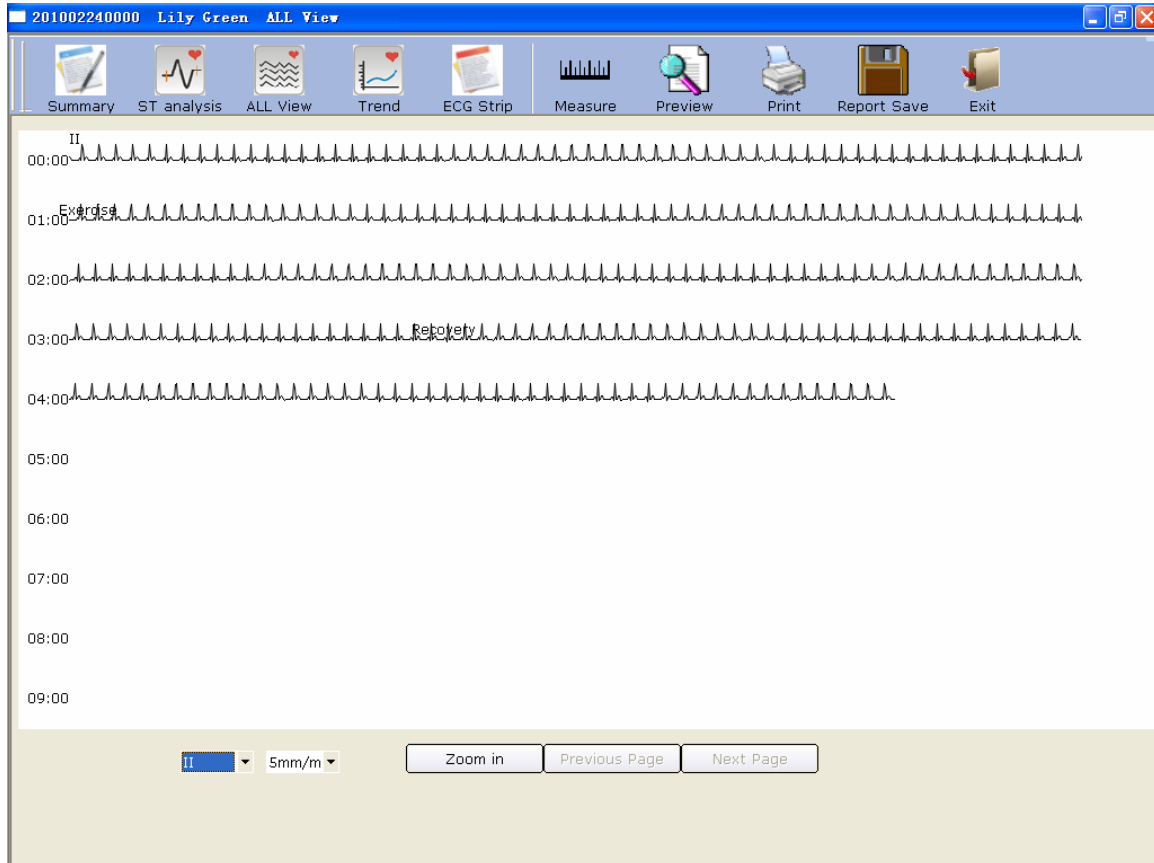
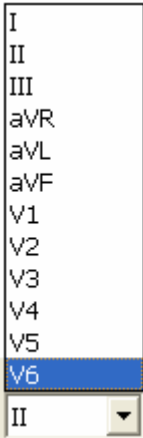
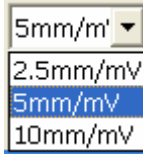
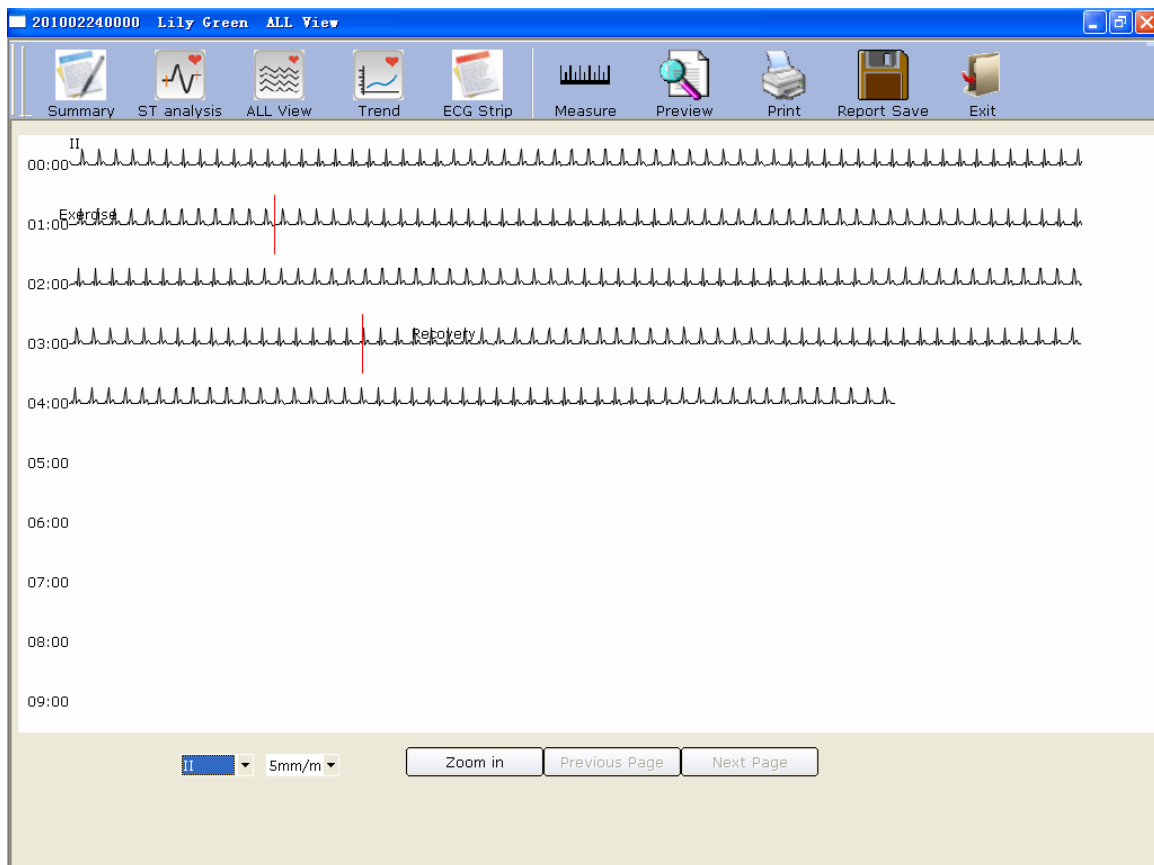


Figure 7-6 All View Screen

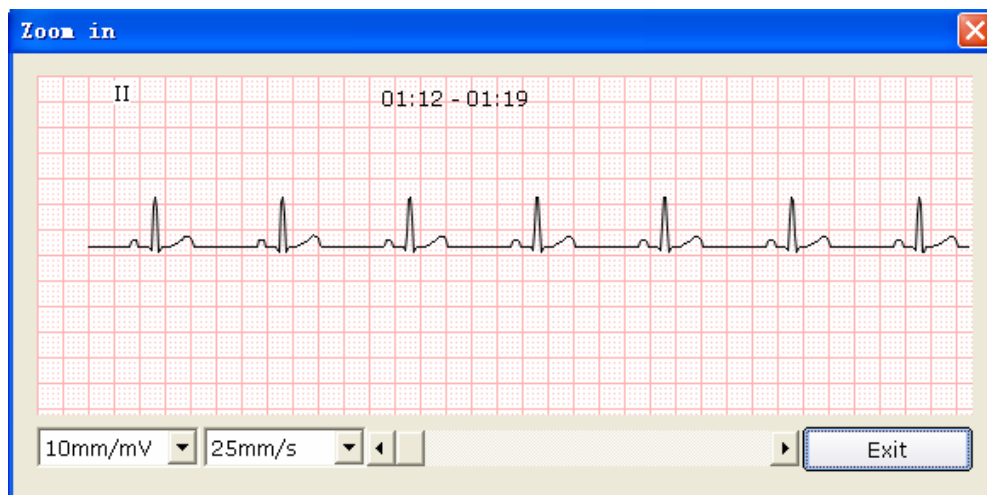
The **ALL View** screen displays the ECG wave of one lead throughout the whole test, and arrhythmia will be marked in red signs.

2. Select a lead from the lead pull-down list  to view the ECG wave of the lead.
3. Select a gain from the gain pull-down list .

4. Click on one point on the wave and drag the mouse to another point, and then the selected range will be marked with two red lines.



Then click on the **Zoom in** button to display the amplified ECG segment.



Drag the bottom scroll bar to view the whole amplified ECG waves.

5. The **ALL View** screen displays ECG waves of 450 seconds (50 seconds in one line and at least 9 lines in one page). ECG waves exceeding 450 seconds can be reviewed by clicking on the **Previous Page/Next Page** button.

7.9.4 About Trend Screen

Click on the **Trend** button to display the **STj Trend** screen.

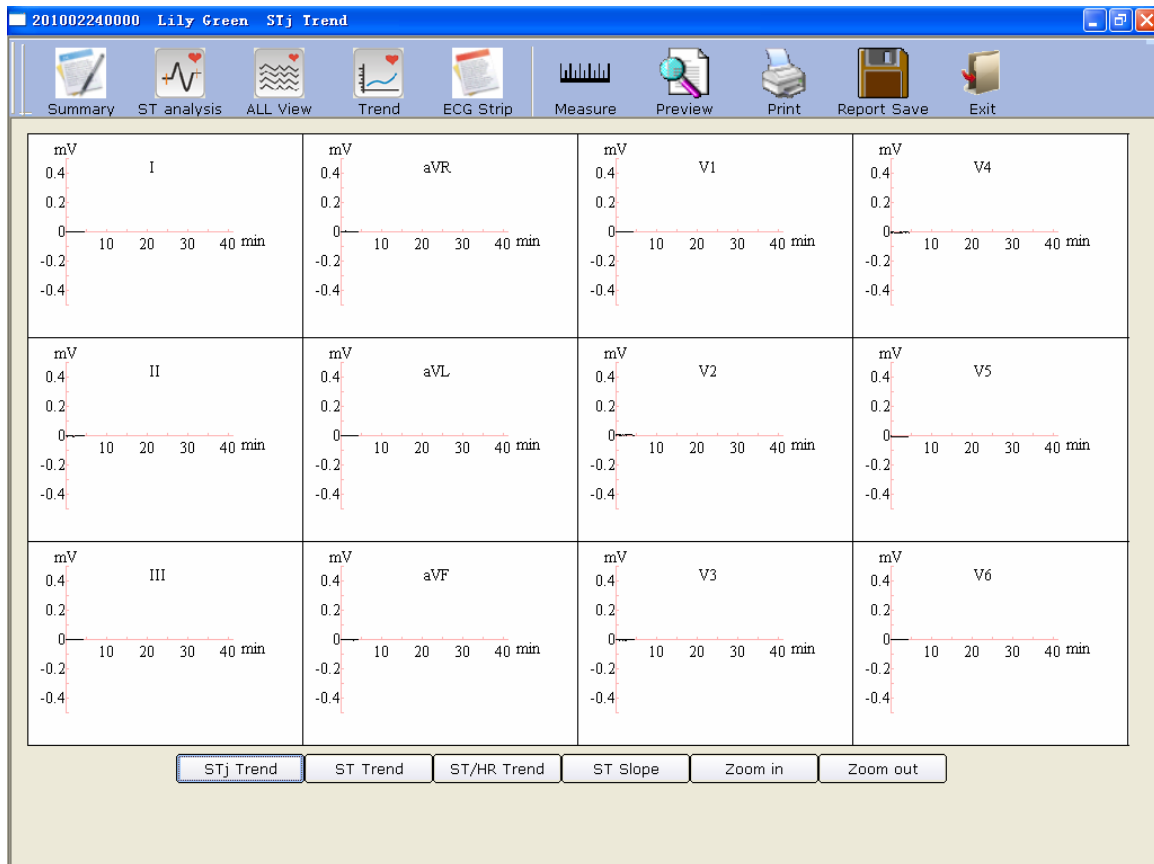


Figure 7-7 STj Trend Screen

You can observe 12-lead trend of the exercise test on the **STj Trend** screen.

The horizontal coordinate indicates test time, but the unit of the vertical coordinate is different on different trend screens.

Click on **Zoom In** or **Zoom Out** button to adjust the value on the vertical coordinate.

7.9.5 About ECG Strip Screen

Click on the **ECG Strip** button to display the **ECG Strip** screen.

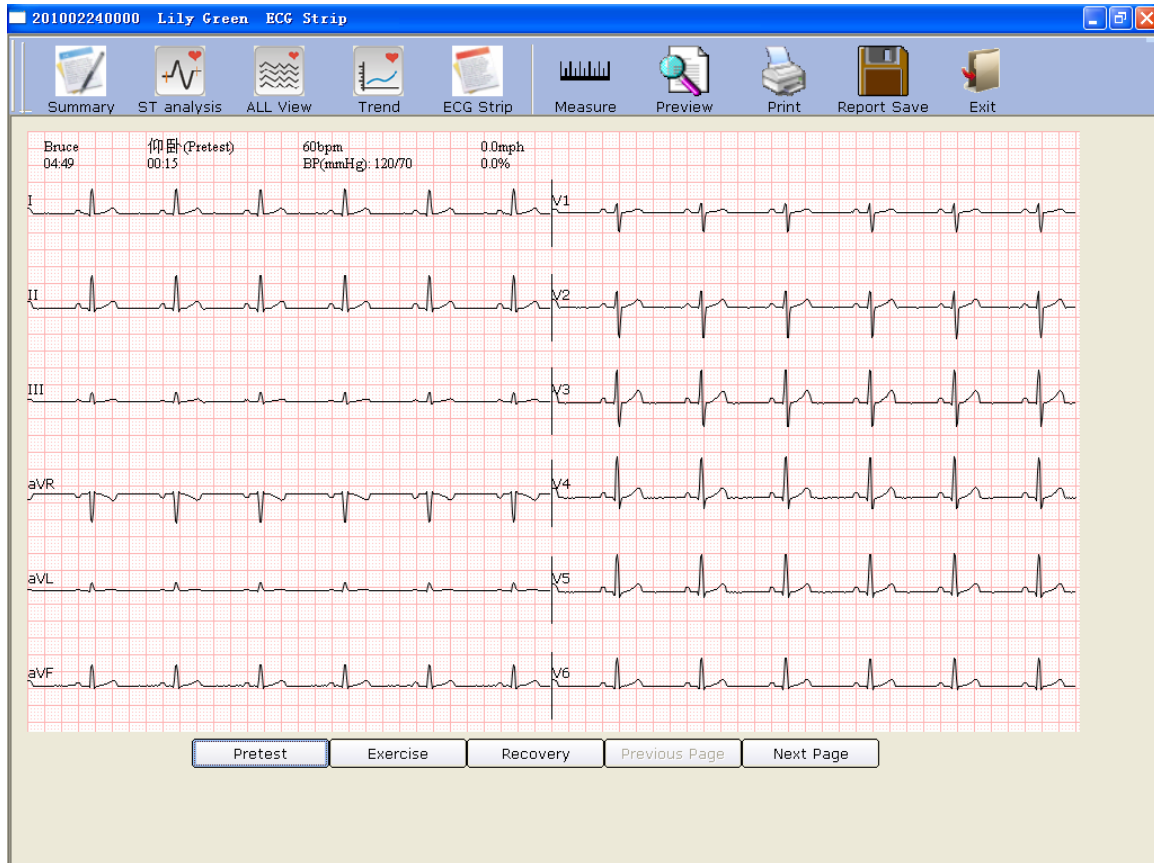


Figure 7-8 ECG Strip Screen

1. Click on **Pretest** to display 12-lead strip waves of the pretest phase.
2. Click on **Exercise** to display 12-lead strip waves of the exercise phase.
3. Click on **Recovery** to display 12-lead strip waves of the recovery phase.
4. Click on **Previous Page/Next Page** to display strip waves of every 30 seconds.

7.9.6 Previewing ECG Reports

Click on the **Preview** button to preview an ECG report.

7.9.7 Printing ECG Reports

You can print an ECG report by clicking on the **Print** button. For details, please refer to Section 6.6.10, “Printing ECG reports”.

7.9.8 Saving ECG Reports

You can save an ECG report by clicking on the **Report Save** button. For details, please refer to Section 6.6.11, “Saving ECG reports”.

7.9.9 Exiting the Analysis Screen

Click on the **Exit** button on the analysis screen to return to the previous screen.

Chapter 8 Processing Patient Records

Click on the **Data Manager** button on the main screen (Figure 6-1) to open the **Data Manager** screen (Figure 8-1).

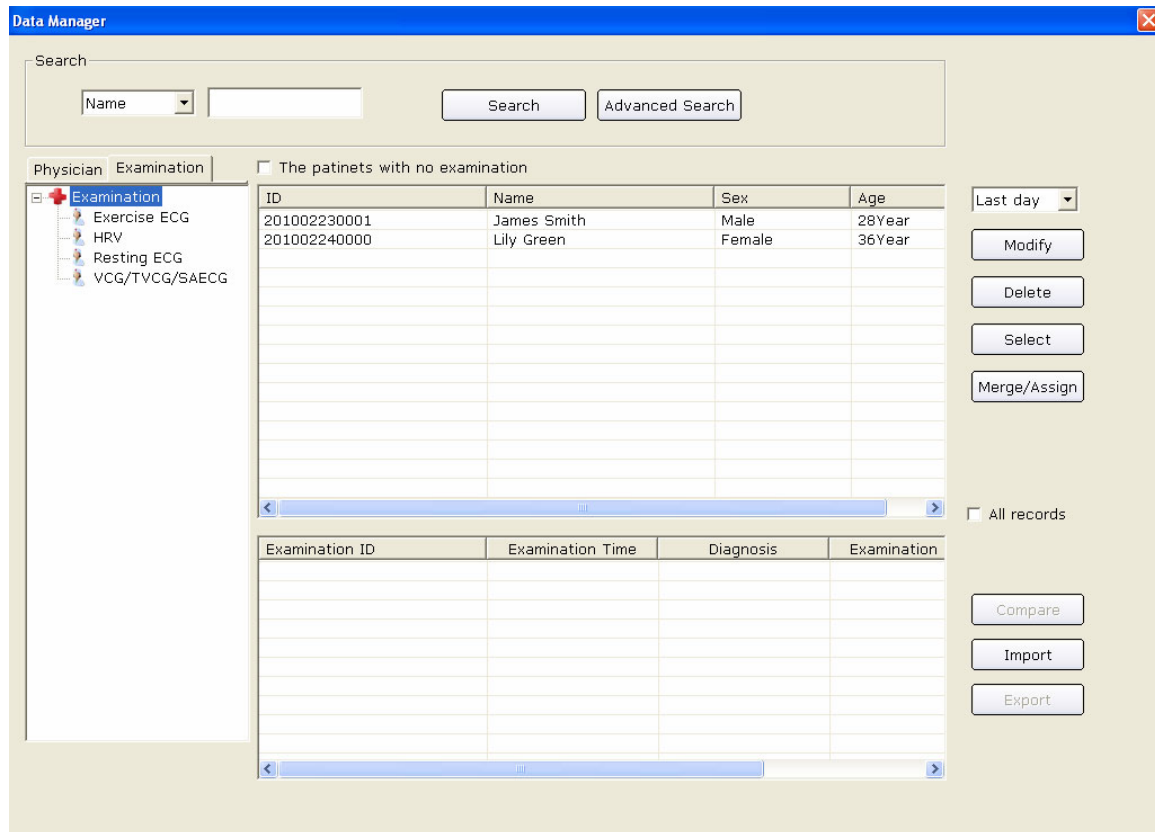
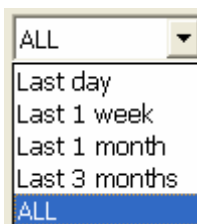


Figure 8-1 Data Manager Screen

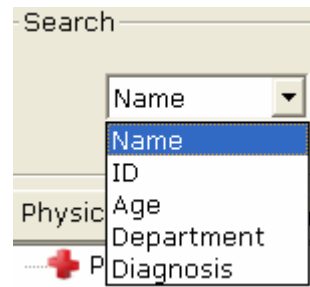
Click on a patient record in the patient information list, and then all the examination records of the patient will be displayed in the examination record list.

NOTE: Click on an option in the patient information list, such as ID, name, etc, and then all the patient records will be arranged in sequence.

8.1 Searching Patient Records



1. Select a search item in the pull-down list **ALL** on the **Data Manager** screen. Then all the patient records which meet the search condition are listed in the patient information list.



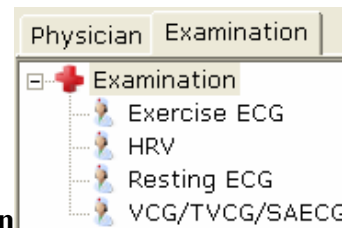
- Or, select a search item in the pull-down list, enter the corresponding information in the right textbox, and then click on the **Search** button. All the patient records which meet the conditions will be displayed in the patient information list.
- Or, click on **Advanced Search** to display the **Search Condition** window, and then enter the search conditions. Click on the **Search** button, and all the patient records which meet the conditions will be displayed in the patient information list.

NOTE: User-defined 1 and User-defined 2 are unavailable before they are set in the **Basic Information** window (Figure 9-1).

A screenshot of the "Search Condition" window. The window has a blue title bar with the text "Search Condition" and a close button (X). The main area is light beige and contains several search criteria with checkboxes and textboxes:

- Pat. ID [text box]
- Name [text box]
- Examination Time [2000- 1- 1] - [2011-12-20]
- User-Defined 1 [text box]
- User-Defined 2 [text box]
- Age range
- Department
- Diagnosis [text box]

At the bottom, there are two buttons: "Search" and "Cancel".



4. Or, you can click on **Physician** or **Examination** the doctor name or examination types, all the patient records which meet the conditions will be displayed in the patient information list.
5. Select **The patients with no examination**, and then the patient records which are registered but not examined, will appear in the patient information list.

8.2 Modifying Patient Records

Click on a patient record in the patient information list on the **Data Manager** screen, and then click on the **Modify** button to display the **Patient Information** window. Then you can modify the information of the patient in the **Patient Information** window. If the patient has more than one record, the modification is only for the selected record. Click on the **OK** button to save these modifications.

 A screenshot of a 'Patient Information' window. The window has a blue title bar with the text 'Patient Information' and a close button (X) on the right. The main area is divided into two sections. The left section contains several input fields: 'ID(*)' with the value '201002040000', 'Name' (empty), 'Gender' with radio buttons for 'M', 'F', and 'N/A' (where 'F' is selected), 'Age' with a text box containing '35' and a 'Year' dropdown menu, 'Dept.' with a dropdown menu, 'Room No.' with a text box, and 'Physician' with a dropdown menu. The right section contains a list of radio buttons for examination types: 'Resting ECG' (selected), 'Exercise ECG', 'HRV ECG', and 'VCG/TVCG/SAECG'. Below these is a checkbox for 'Pacemaker' which is unchecked. At the bottom right of the window are two buttons: 'OK' and 'Cancel'.

8.5 Merging Examination Records

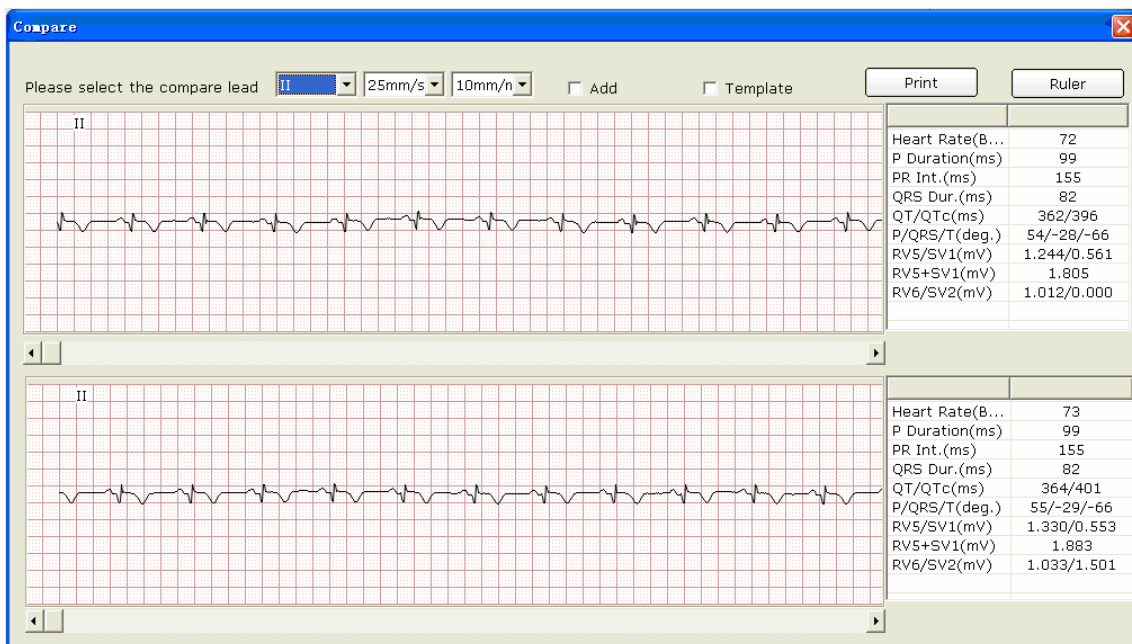
Click on one or more examination records in the examination record list on the **Data Manager** screen, and then click on the **Merge/Assign** button to display the **Patient Information** window. Input a patient ID and click on the **OK** button to assign the examination record selected to this patient.

8.6 Comparing Two Examination Records

Press the **Ctrl** button on the keyboard and select two examination records of resting ECG, and then click on the **Compare** button to display the **Compare** window.

NOTE: Please select two records to compare only in Resting ECG.

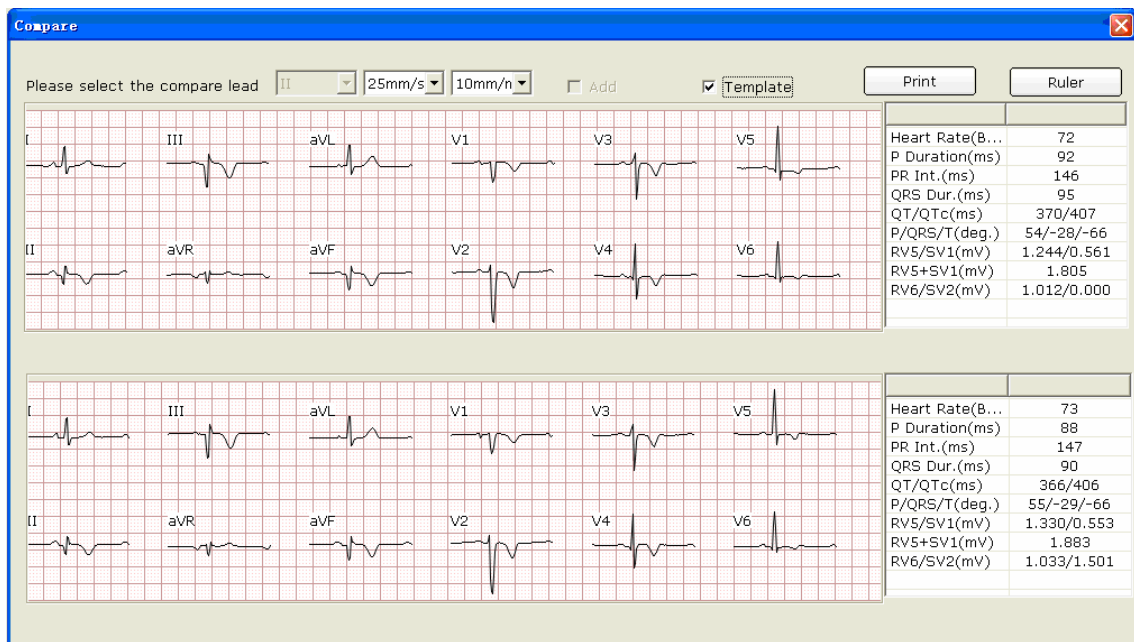
You can select the lead, speed and gain to be compared from the lead pull-down list. Then the waves of the selected lead, speed and gain of the two examination records will be displayed in the window. You can drag the scroll bar on the bottom to view all the waves of the selected lead.



When **Add** is selected, the waves of the two examination records will be displayed in the window. The black wave is the original wave and the blue wave is the compared wave. You can drag the scroll bar on the bottom to view all the waves of the two examination records.

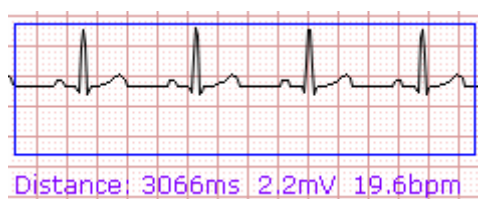


When **Template** is selected, the templates of the two examination records will be displayed in the window.



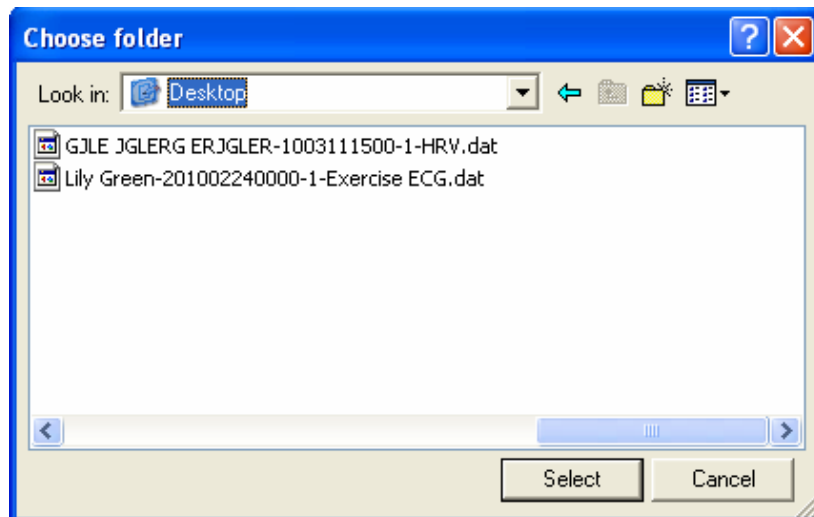
You can press **Print** button to print the current window.

Click on the **Ruler** button on the **Compare** window. Click on one point on the wave, and then drag the mouse to another point. The distance, amplitude difference and heart rate between the two points will be displayed.

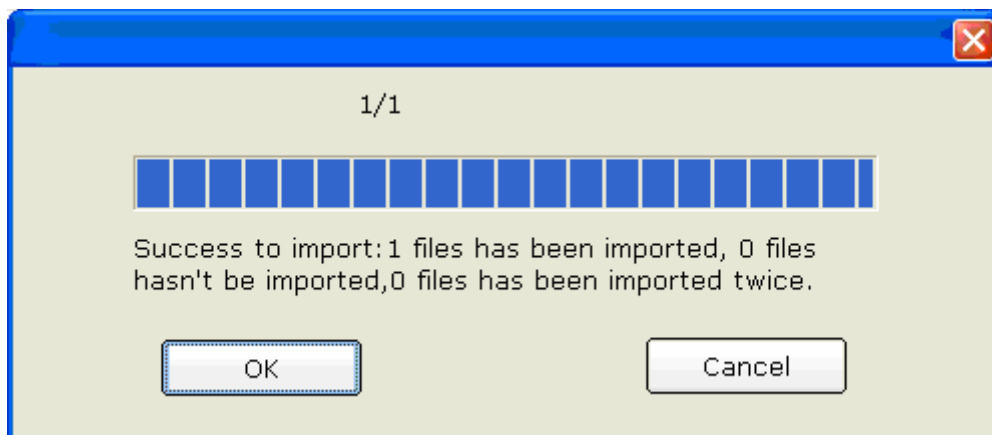


8.7 Importing ECG Data into the Data Manager Screen

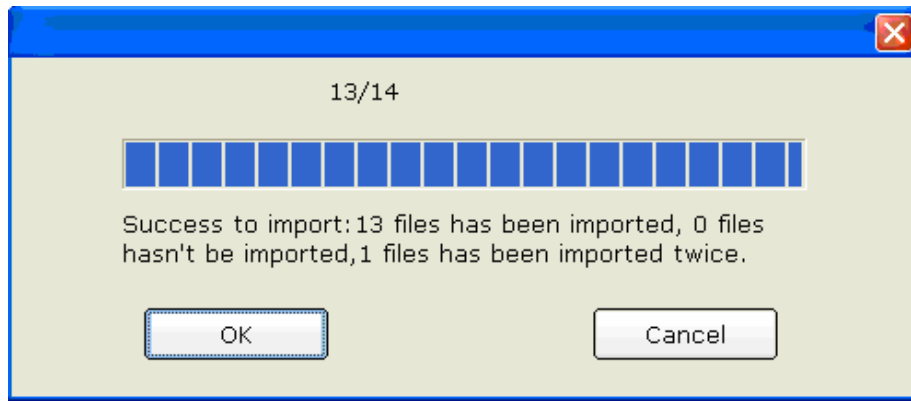
Click on the **Import** button on the **Data Manager** screen (Figure 8-1) to open the following window.



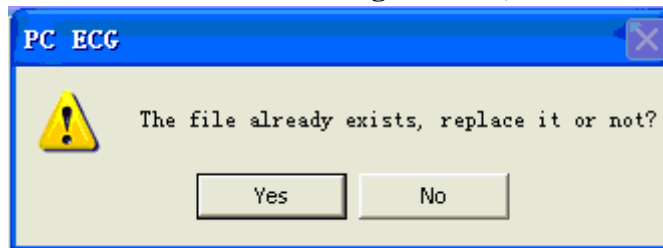
Select the data to be imported and click on the **Select** button to import the data into the **Data Manager** screen.



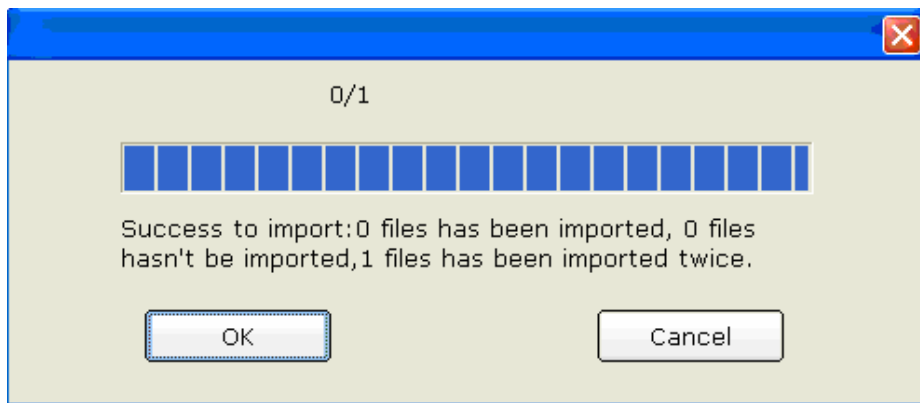
To import multiple examination records simultaneously, you can click on the first examination record to be imported and press the **Shift** button on the keyboard, and then click on the last examination record to be imported. You can also press the **Ctrl** button on the keyboard and then select the examination records one by one. After selecting all the examination records to be imported, click on the **Select** button to import all the examination records into the **Data Manager** screen. If all the data are successfully imported into the screen, the following hint will pop up.



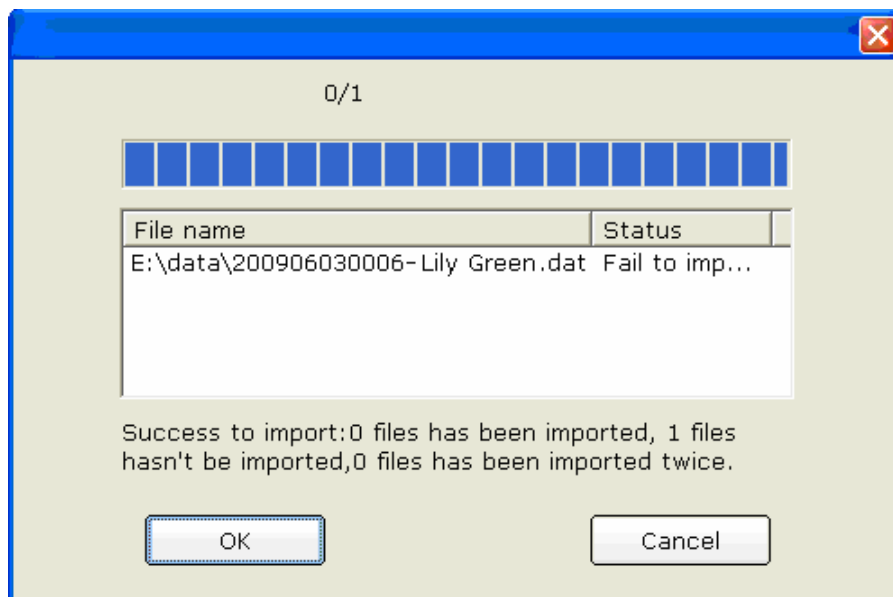
If the data to be imported exists on the **Data Manager** screen, the following hint will pop up.



If you press the **Yes** button, the imported record will replace the file with the same name.



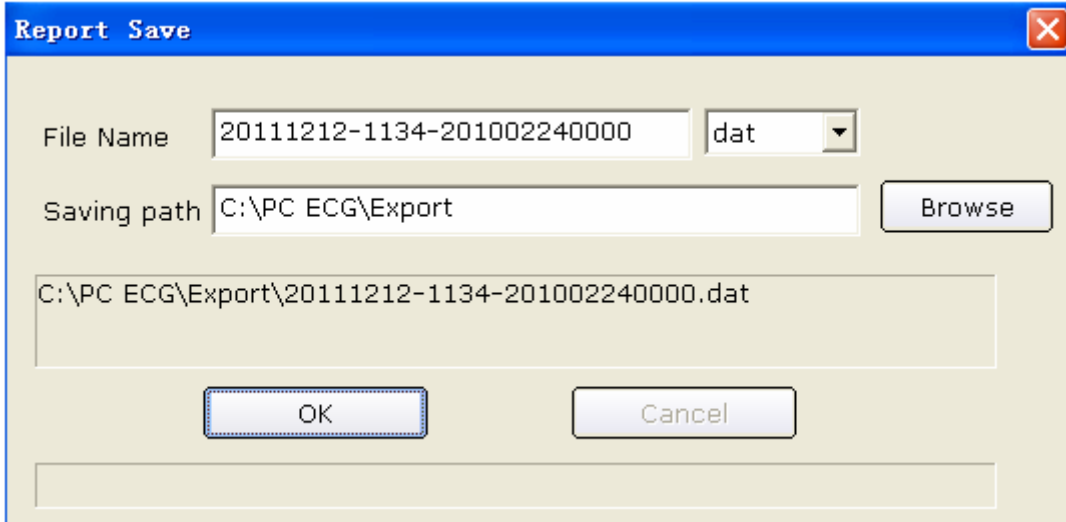
If you press the **No** button, the system will hint you a failure operation occurs.



NOTE: Only ECG data in DAT format can be imported.

8.8 Exporting ECG Data from the Data Manager Screen

Select examination records and click on the **Export** button on the **Data Manager** screen (Figure 8-1) to open the following window. Assign the file name, saving path and export file format (SCP, FDA-XML, DICOM, dat, pdf), and then click on the **OK** button to export the data into the selected path. At the same time, the patient information of these records will be exported.

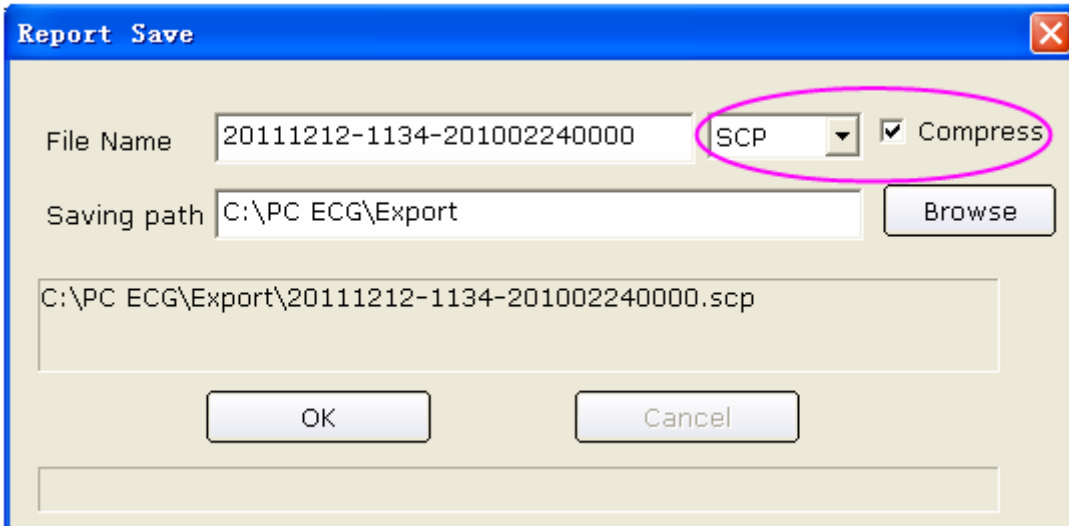


The screenshot shows a 'Report Save' dialog box with the following fields and controls:

- File Name:** 20111212-1134-201002240000
- Format:** dat (selected in a dropdown menu)
- Saving path:** C:\PC ECG\Export
- Browse:** Button to the right of the saving path field.
- Preview:** C:\PC ECG\Export\20111212-1134-201002240000.dat
- Buttons:** OK and Cancel.

When the export is successful, the hint information will be displayed.

If you select **SCP** and **Compress**, the compressed SCP file will be exported.



The screenshot shows the 'Report Save' dialog box with the following fields and controls:

- File Name:** 20111212-1134-201002240000
- Format:** SCP (selected in a dropdown menu, circled in pink)
- Compress:** (checked, circled in pink)
- Saving path:** C:\PC ECG\Export
- Browse:** Button to the right of the saving path field.
- Preview:** C:\PC ECG\Export\20111212-1134-201002240000.scp
- Buttons:** OK and Cancel.

NOTE: Only if the export file format is set to **SCP**, can the **Compress** check box be displayed.

If you select **pdf**, the pdf file will be exported only for Resting ECG and Exercise ECG. You need to enter the analysis screen to export pdf files for HRV ECG, VCG, TVCG and SAECG.

8.9 Viewing an Examination Record

Click on a patient record in the patient information list, and then all the records of the patient will be displayed in the examination record list.

Select **All records** and all the examination records will be displayed in the examination record list.

Double-click on an examination record in the examination record list on the **Data Manager** screen (Figure 8-1). If it is a Resting ECG record, the Resting ECG analysis screen will pop up. If it is an HRV record, the HRV analysis screen will pop up. If it is a VCG/TVCG/SAECG record, the VCG/TVCG/SAECG analysis screen will pop up. If it is an Exercise ECG record, the Exercise ECG analysis screen will pop up. Then you can do the corresponding operation to the examination record. For details, please refer to Section 6.6, “Analyzing ECG Data” and Section 7.9, “About Analysis Screen”.

Chapter 9 Configuring the System

Click on the **System Setting** button on the main screen (Figure 6-1) to open the **System Setting** window.

There are eight tabs in the **System Setting** window: **Basic Information**, **Sample Setting**, **Device**, **Print Setting**, **Output File**, **Data Maintenance**, **GDT** and **Others**.

After you modify some information in the **System Setting** window,

1. Click on the **OK** button to save these modifications and exit.
2. Or, click on the **Cancel** button to cancel these modifications and exit.

9.1 Basic Information Setup

Click on the **Basic Information** tab in the **System Setting** window to display the **Basic Information** window.

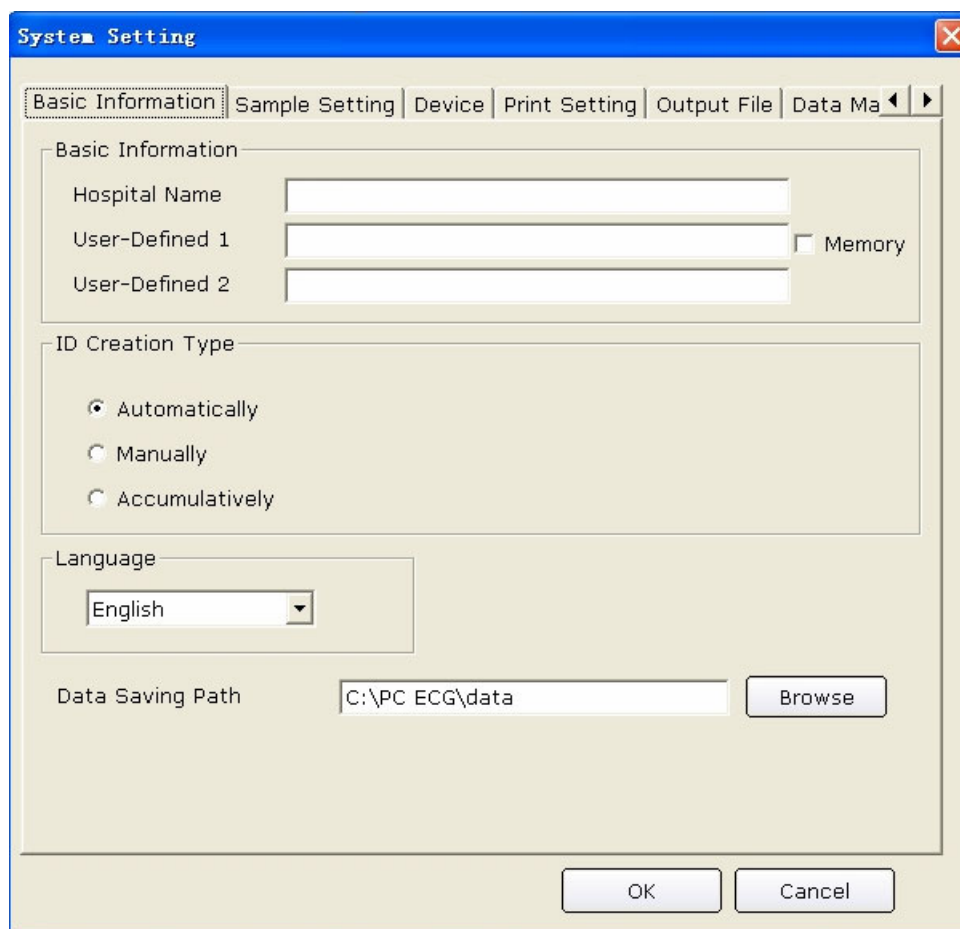


Figure 9-1 Basic Information Setup Window

9.1.1 Setting Basic Information

Enter information in the **Hospital Name**, **User-Defined 1** or **User-Defined 2** textbox in the **Basic Information** window (Figure 9-1).

When you fill in the **User-Defined 1/2** textbox, the corresponding items in the **Patient Information** window will change into what is filled.

For example, when you enter **Allergies** in the **User-Defined 1** textbox, and enter **Other** in the **User-Defined 2** textbox in the **Basic Information** window (Figure 9-1), the corresponding items in the **Patient Information** window will be **Allergies** and **Other** respectively.

(a)

(b)

NOTE: Click on the **New Patient** button on the main screen to open the **Patient Information** window as the above figure shows.

Select **Memory** in **Basic Information** window, the content of **User-Defined 1** in the **Patient Information** window will be saved. For example, when you enter **None** in the **Allergies** textbox of picture (a), and enter **None** in the **Other** textbox of picture (b), click **OK** and open the **Patient Information** window again, you will find that **None** is in **Allergies** textbox and the **Other** textbox is empty. If **Memory** is not selected, the **Allergies** textbox and the **Other** textbox are all empty.

9.1.2 Setting ID Mode

Set **ID Create Type** to **Automatically**, **Manually** or **Accumulatively**.

When **ID Create Type** is set to **Automatically**, the patient ID can be automatically generated according to the examination date.

When **ID Create Type** is set to **Manually**, you should enter the patient ID manually in the **Patient Information** window.

When **ID Create Type** is set to **Accumulatively**, the patient ID can be increased by one automatically. You need to set the format and the starting number for ID.

9.1.3 Setting Language

You can set the language to **Chinese** or **English**.

NOTE: To validate the language setup, after setting, you should restart the system.

9.1.4 Specifying the Storage Path of the ECG Data

Click on the **Browse** button in the **Basic Information** window (Figure 9-1) to assign the storage path.

9.2 Sample Setup

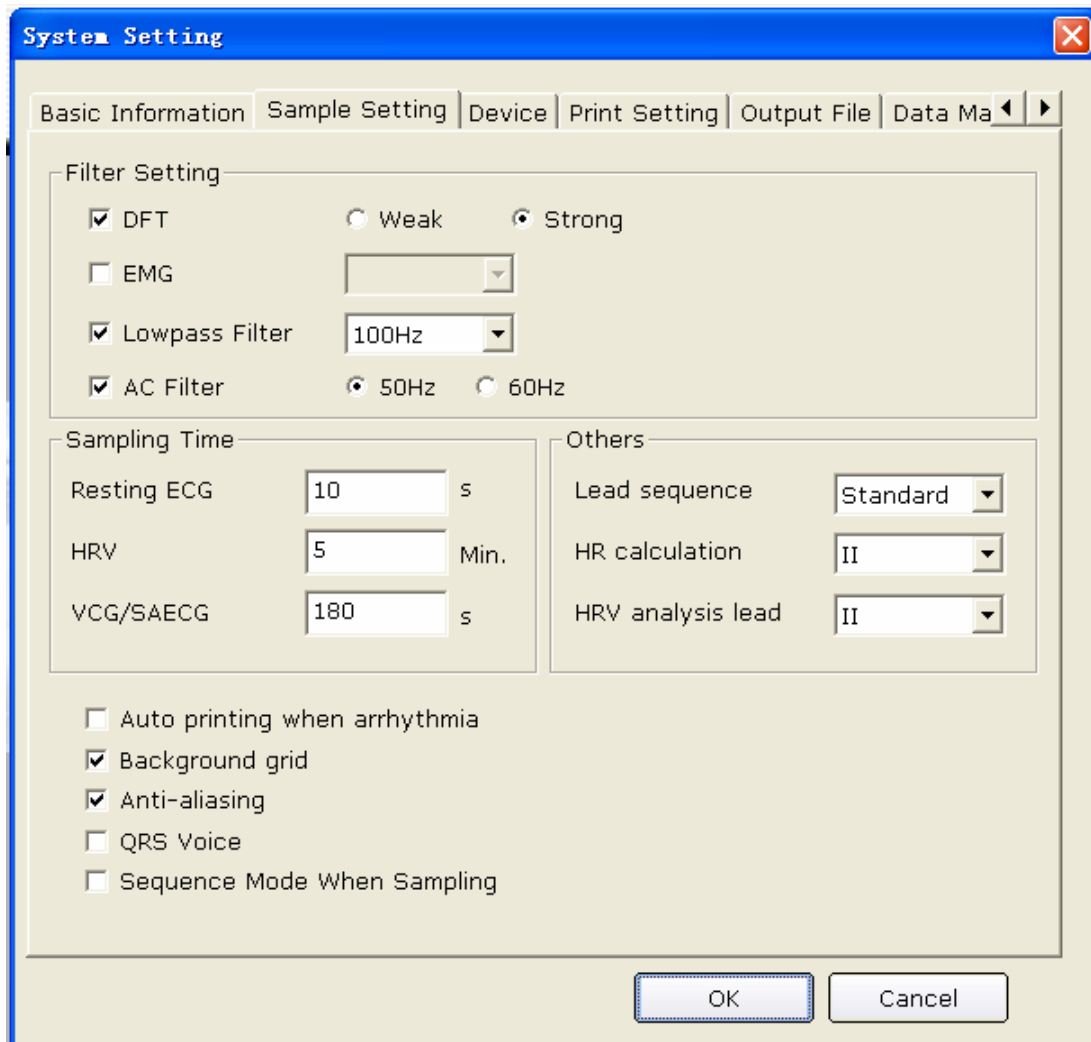
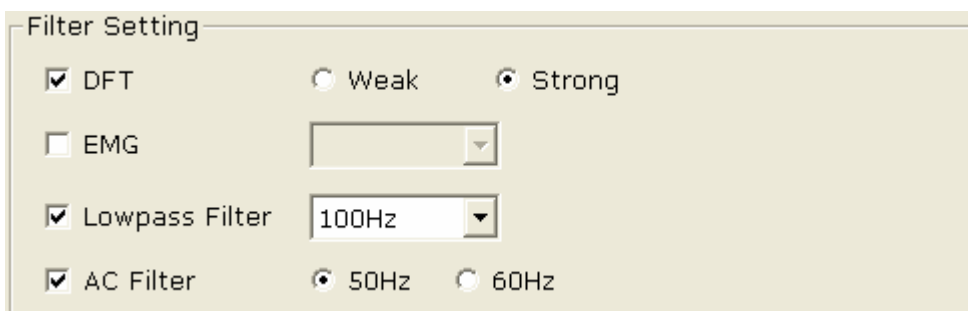


Figure 9-2 Sample Setup Window

9.2.1 Setting Filter



Set filters in the **Sample Setting** window (Figure 9-2).

DFT Filter

DFT filter greatly reduces the baseline fluctuations without affecting ECG signals. There are two options: **Weak** and **Strong**.

NOTE: If DFT filter is set to **Strong**, the ECG data displayed on the screen is 0.85 seconds later than the real-time ECG data; if DFT filter is set to **Weak**, the ECG data displayed on the screen is 1.8 seconds later than the real-time ECG data.

EMG Filter

EMG filter suppresses the disturbance caused by strong muscle tremor. The cutoff frequency can be set to **25Hz**, **35Hz**, or **45Hz**.

Lowpass Filter

Lowpass filter restricts the bandwidth of input signals. The cutoff frequency can be set to **75Hz**, **100Hz** or **150Hz**. All the input signals whose frequency is higher than the setting cutoff frequency will be attenuated.

AC Filter

AC filter suppresses AC interference without attenuating or distorting ECG signals. There are two options: **50Hz** and **60Hz**.

9.2.2 Setting Sampling Time

You can enter the normal ECG sampling time manually. The range is 10~600s.

You can enter the HRV sampling time manually. The range is 1~15min.

You can enter the sequence mode time manually. The range is 10~900s.

9.2.3 Others**◆ Lead Sequence**

You can set **Lead sequence** to **Standard** or **Cabrera**, and the lead groups are displayed or printed in the corresponding sequence listed in the following table.

Lead Sequence	Lead group 1	Lead group 2	Lead group 3	Lead group 4
Standard	I, II, III	aVR, aVL, aVF	V1, V2, V3	V4, V5, V6
Cabrera	aVL, I, -aVR	II, aVF, III	V1, V2, V3	V4, V5, V6

◆ **HR Calculation**

You can set the **HR calculation** to one of the 12 standard leads: I, II, III, aVR, aVL, aVF, V1, V2, V3, V4, V5, or V6.

◆ **HR Analysis Lead**

You can set the **HR Analysis Lead** to one of the 12 standard leads: I, II, III, aVR, aVL, aVF, V1, V2, V3, V4, V5, or V6.

9.2.4 Selecting Auto Printing When Detecting Arrhythmia

When **Auto printing when arrhythmia** is selected, if Arrhythmia ECG data, including Ventricular Tachycardia, $5 > \text{PVCS} \geq 3$, Paired PVCS, Bigeminy, Trigeminy, R ON T, single PVC and Missed Beat, is detected during the sampling course, printing will be triggered automatically.

9.2.5 Setting Background Grid

Select **Background Grid**, the grid on the background of the ECG sampling screen will be displayed.

Deselect **Background Grid**, the grid on the background of the ECG sampling screen will not be displayed.

9.2.6 Setting Anti-aliasing

Select **Anti-aliasing**, the system will automatically make the waveform smooth.

Deselect **Anti-aliasing**, the system will not make the waveform smooth.

9.2.7 Selecting QRS Voice

If you select **QRS Voice**, there will be a beep when an R wave is detected.

9.2.8 Selecting Sequence Mode When Sampling

When **Sequence Mode When Sampling** is selected, groups of waves will be displayed in succession.

9.3 Device Setup

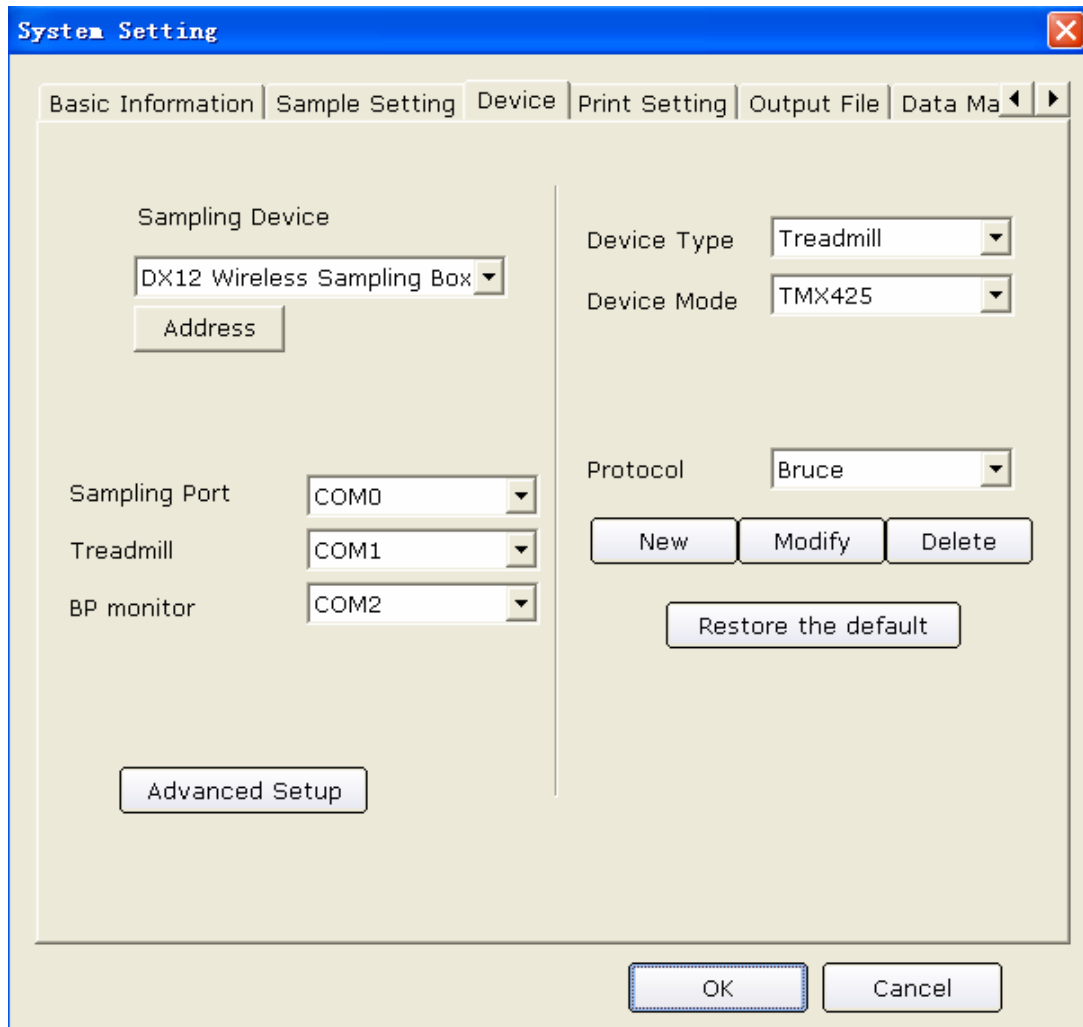
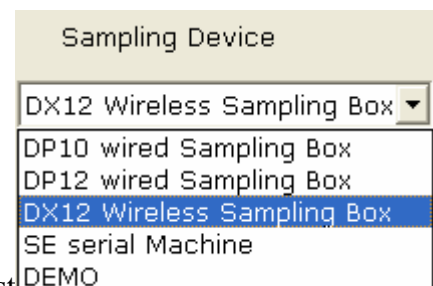


Figure 9-3 Device Setup Window

9.3.1 Setting Sampling Device



Select a sample device from the **Sampling Device** pull-down list in the **Device** window (Figure 9-3).

When **DX12 wireless sampling box** is selected, you can click on the **Address** button to view the receiver address. You can match the transmitter and receiver based on the address

from the **Sampling Device** pull-down list.

9.3.2 Setting Device Type/Mode

Select a device type/mode from the **Device Type/Device** pull-down list

9.3.3 Setting COM Port of Sample/Treadmill/BP Monitor

Select the COM port for sampling/treadmill/BP monitor from the corresponding pull-down lists

To guarantee the system's proper operation, one of the preconditions is to ensure that the connection between the peripheral equipment and the PC accords with the setup in the software. For example, if you set the treadmill port to **COM2**, you should connect the treadmill to COM2 of the PC; if you set the BP monitor port to **COM3**, you should connect the BP monitor to **COM3** of the PC.

9.3.4 Setting a Protocol

Select a protocol from the **Protocol** pull-down list also add a new protocol or modify a protocol.

You can

9.3.4.2 Modifying a Protocol

1. Select a protocol from the **Protocol** pull-down list, and then click on the **Modify** button to display the **Edit Protocol** window.

The screenshot shows the 'Edit the protocol' window with the protocol name 'Bruce'. The table below represents the data shown in the window:

Phase	Stage	Stage tim...	Speed(mph)	Slope(%)	12-lead ECG Report...	12-lead ECG Report...	BP(First)
Pretest	Supine	99.0	0.0	0.0	1.0	--	0.1
Pretest	Sitting	99.0	0.0	0.0	1.0	--	--
Pretest	Standing	99.0	0.0	0.0	1.0	--	--
Pretest	Deep Breath	99.0	0.0	0.0	1.0	--	--
Pretest	Warm-up	99.0	1.0	0.0	1.0	--	--
Exercise	Stage1	3.0	1.7	10.0	2.5	--	1.0
Exercise	Stage2	3.0	2.5	12.0	2.5	--	1.0
Exercise	Stage3	3.0	3.4	14.0	2.5	--	1.0
Exercise	Stage4	3.0	4.2	16.0	2.5	--	1.0
Exercise	Stage5	3.0	5.0	18.0	2.5	--	1.0
Exercise	Stage6	3.0	5.5	20.0	2.5	--	1.0
Exercise	Stage7	3.0	6.0	22.0	2.5	--	1.0
Recovery	Recovery1	1.0	1.5	0.0	0.0	--	0.0
Recovery	Recovery2	2.0	0.0	0.0	0.0	2.0	1.0
Recovery	Recovery3	99.0	0.0	0.0	2.0	4.0	1.0

Hint: 1.Right click the mouse to add or remove the stage. 2. Double click the mouse to modify the stage information. 3. 12 lead ECG report(First/Repeat) is the auto-printing time of ECG report of each stage,please don't set the time longer than the stage time. 4.BP(First/Repeat) is the auto-measuring time of BP of each stage, please don't set the time longer than the stage time.

2. Double-click on an option of the phase row to be modified in the protocol list, and the

The screenshot shows a pull-down list with the following options: Pretest, Exercise, and Recovery. The 'Pretest' option is currently selected.

pull-down list will be displayed. Select a phase and it will be displayed in the corresponding grid.

3. Double-click on the grid to be modified, input new information, and click on any other grid to save the information.

The screenshot shows a context menu with two options: 'Add stage' and 'Delete stage'.

4. Right-click on the grid to display the menu, click on **Add Stage**, and enter information in the grid.
5. Set the auto printing time of 12-lead ECG reports in the **12-lead ECG Report (First)** and **12-lead ECG Report (Repeat)** columns.
6. Set the auto BP sampling time in the **BP (First)** or **BP (Repeat)** columns.
7. Click on the **OK** button to confirm, or click on the **Cancel** button to cancel modifications.

9.3.4.3 Deleting a Protocol

Select a protocol from the **Protocol** pull-down list, and then click on the **Delete** button to delete the protocol.

NOTE: You can't delete default protocols Bruce and IsoPower.

9.3.4.4 Restoring the default protocol

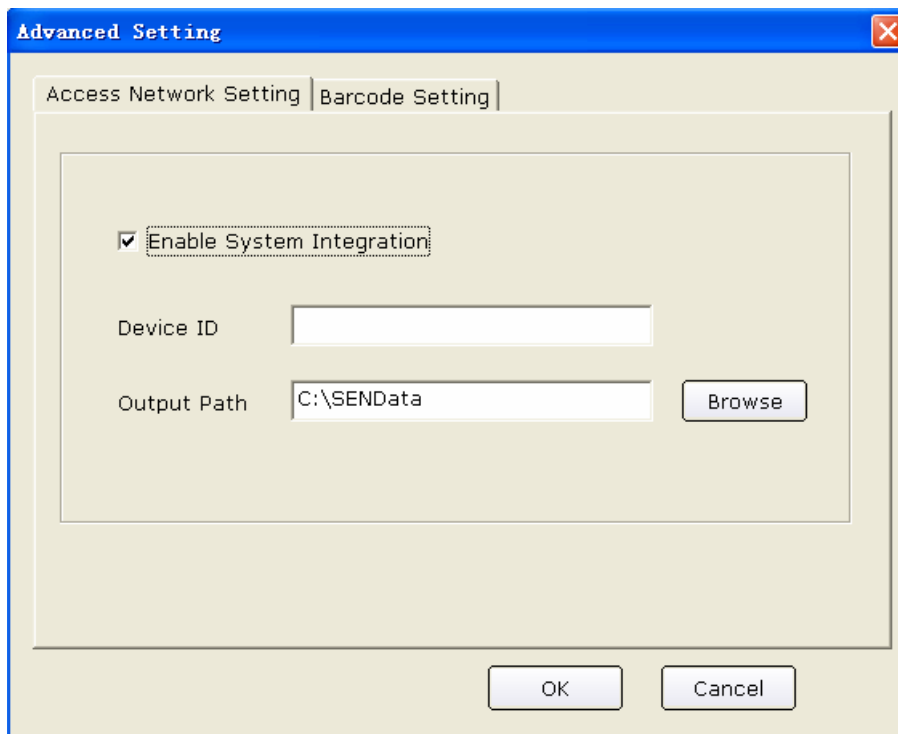
Click on the **Restore the default** button to resume the default protocol.

9.3.5 Advanced Setup

Click on **Advanced Setting**, input the correct password in the pop-up textbox, and then click on the **OK** button.

9.3.5.1 Setting Access Network

Click on the **Access Network Setting** tab to display the following window.



Only if **Enable System Integration** is selected, can **Device ID** and **Output Path** be set.

Device ID and **Output Path** should be set to the same values as those of Smart ECG Net. Otherwise, data of this system can not be uploaded to Smart ECG Net system normally.

If the System Integration is activated, the system will save two copies of data, one is saved to the data path of the system, and the other is saved to the output path, the default of which is system disk: \SENDData\.

9.3.5.2 Setting Barcode

Click on the **Barcode Setting** tab to display the following window.

Item	Start Add.	End Add.	Item	Start Add.	End Add.
ID	1	12	Year Of Brith	14	17
Last Name	0	0	Month Of Brith	18	19
First Name	0	0	Day Of Brith	20	21
Gender	13	13			
Male Code	1				
Female Code	2				
Device Port	COM3				

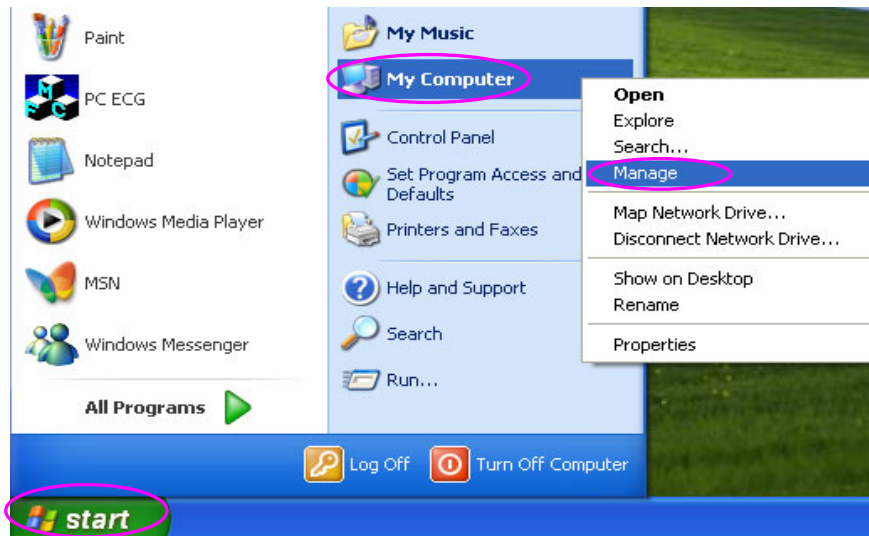
OK Cancel

NOTE: You can make related settings only for two-dimensional bar code readers in the **Barcode Setting** window.

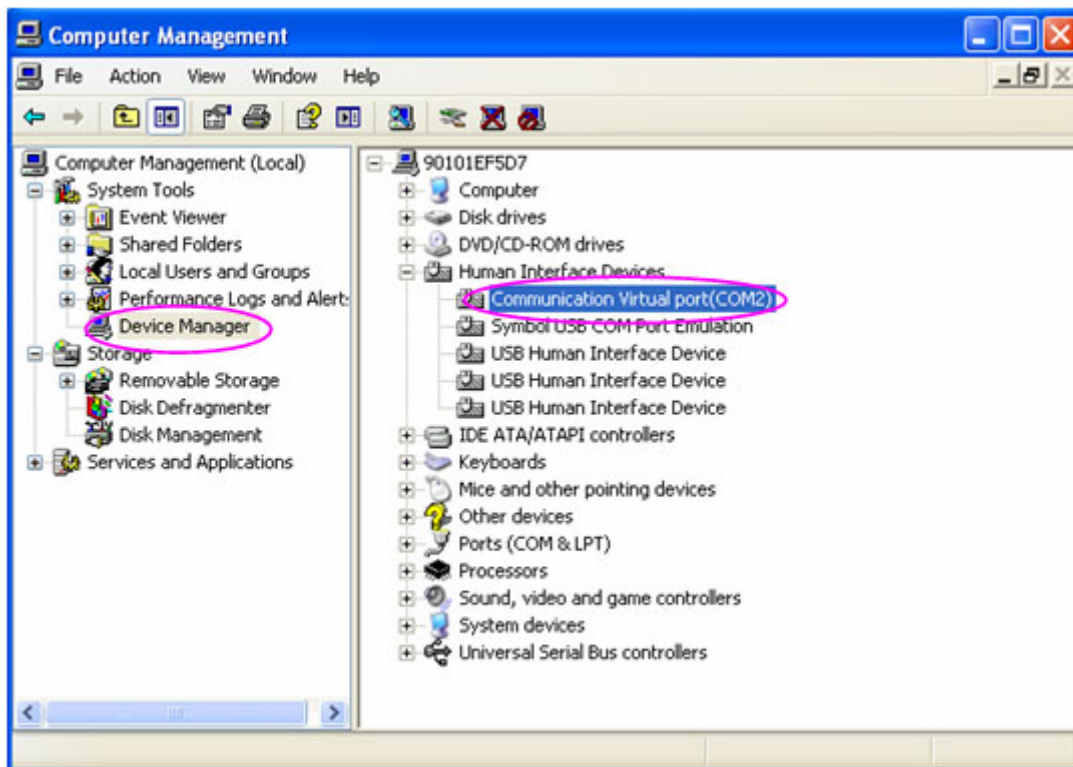
Enter the start and end addresses, the male and female codes and the device port, and then click on the **OK** button confirm.

If the bar code reader cannot be automatically detected, you can make related settings as the following procedures show:

1. Connect the bar code reader to the PC
2. Click on **start**, right-click on **My Computer**, and then select **Manage** in the pop-up menu to display the **Computer Management** screen.



3. Click on **Device Manager** on the **Computer Management** screen, and then click on **Human Interface Devices** to view port information.



4. In the **Barcode Setting** window, set **Device** to the port you view on the **Computer Management** screen, and then click on the **OK** button to confirm.
5. Restart the PC ECG software.

9.4 Print Setup

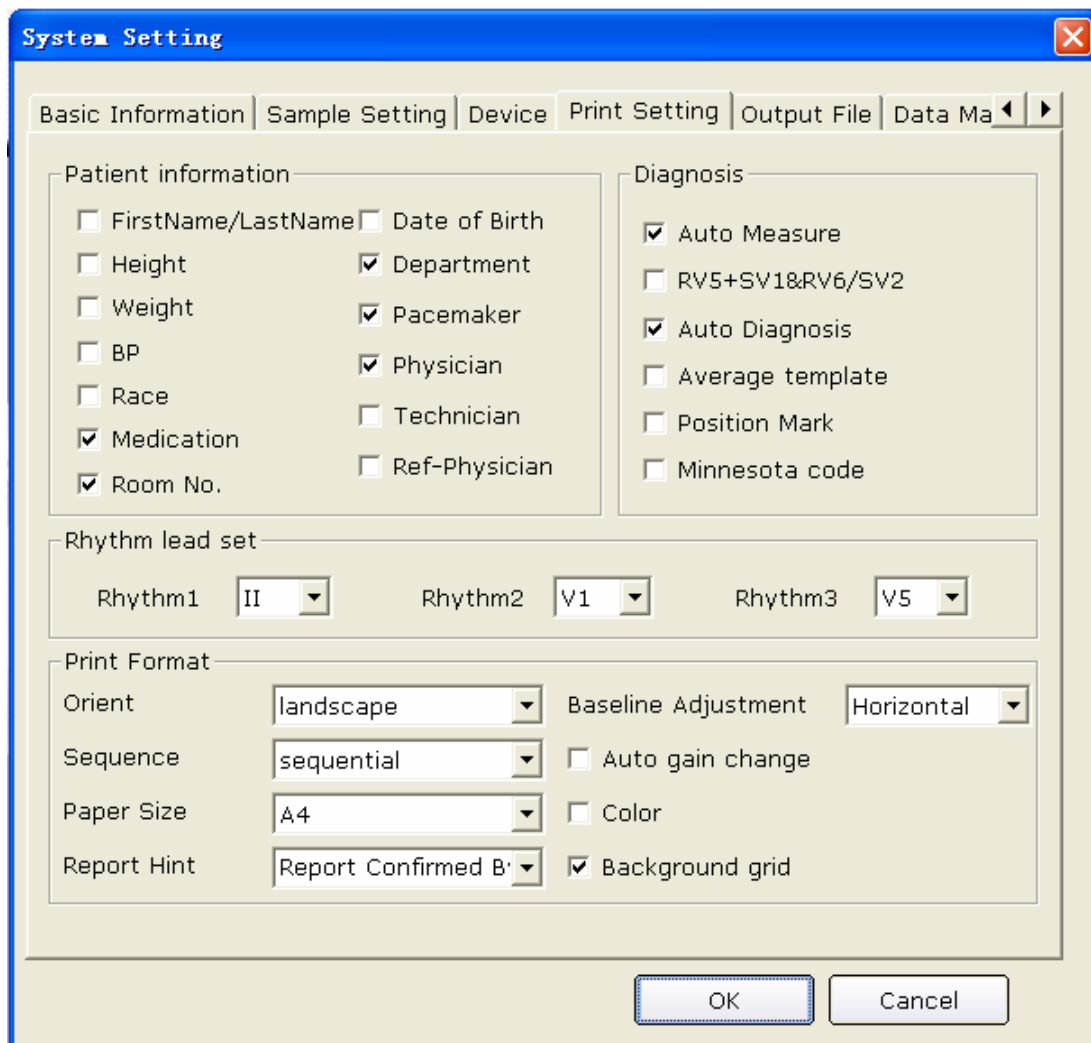


Figure 9-4 Print Setting Window

9.4.1 Choosing Patient Information to be Printed

The default items of the patient information are Department, Room No and Physician. You can also select the additional information, such as FirstName/LastName, Date of Birth, height, weight, BP, race, medication, Pacemaker, Technician and Ref-Physician. The patient information items you selected will be displayed in the **Patient Information** window and the report printed out.

If you select **First Name/Last Name**, the **Patient Name** textbox in the **Patient Information** window will change into the **First Name** and **Last Name** textboxes.

The screenshot shows the 'Patient Information' dialog box. The 'ID(*)' field contains '201002040000'. The 'First Name' and 'Last Name' fields are highlighted with pink circles. The 'Gender' field has radio buttons for 'M', 'F', and 'N/A', with 'F' selected. The 'Age' field contains '35' and 'Year' is selected in the dropdown. The 'Dept.', 'Room No.', and 'Physician' fields are empty. On the right, the 'Resting ECG' radio button is selected, and the 'Pacemaker' checkbox is unchecked. 'OK' and 'Cancel' buttons are at the bottom.

If you select **D.O.B**, the D.O.B textbox appears in the **Patient Information** window, and the **Age** textbox becomes unavailable.

The screenshot shows the 'Patient Information' dialog box. The 'ID(*)' field contains '201002040000'. The 'Name' field is empty. The 'Gender' field has radio buttons for 'M', 'F', and 'N/A', with 'F' selected. The 'D.O.B' field is highlighted with a pink circle and contains a date mask 'YYYY-MM-DD'. The 'Age' field is disabled and contains '0'. The 'Dept.', 'Room No.', and 'Physician' fields are empty. On the right, the 'Resting ECG' radio button is selected, and the 'Pacemaker' checkbox is unchecked. 'OK' and 'Cancel' buttons are at the bottom.

9.4.2 Choosing Diagnosis Information to be Printed

The diagnosis information is displayed on the preview screen and in the report printed out.

Position Mark should be selected together with **Average template**, because the position mark is only used to mark the position of ECG waves in the average template. Select **Auto Diagnosis** to display diagnosis results on the preview screen and in the report printed out. Select **Auto Measure** to display values of parameters. Select **RV5+SV1&RV6/SV2** to display values of RV5+SV1&RV6/SV2. Select **Minnesota code** to display Minnesota code.

9.4.3 Setting Rhythm Lead

The rhythm lead can be one of 12 standard leads: I, II, III, aVR, aVL, aVF, V1, V2, V3, V4, V5, or V6.

When the printing mode is set to **3×4+1** or **6×2+1**, the rhythm lead selected in the **Rhythm1** list box will be printed out.

When the printing mode is set to **3×4+3**, 3 rhythm leads selected in the **Rhythm1**, **Rhythm2** and **Rhythm3** list boxes will be printed out.

9.4.4 Defining Printing Format

1. The paper form can be set to **landscape** or **portrait**.

2. Set **Sequence** to **sequential** or **synchronous**.

When **Sequence** is set to **sequential**, the lead group is printed one by one in a certain sequence. The start time of a lead group is just the end time of the previous lead group.

When **Sequence** is set to **synchronous**, all leads are printed simultaneously. The start time of each group is the same.

3. Set the paper size to **A4** or **Letter**.

4. Set the Report Hint to **Report confirmed by:** or **Unconfirmed Report**.

5. Set the **Baseline Adjustment** to **OFF**, **Horizontal** or **Auto**.

6. Select **Auto gain change**, and the gain will be changed automatically and **Auto baseline** will be changed to **Horizontal** automatically.

7. Select **Color** and the background grid of report will be printed in color.

Deselect **Color**, and the background grid of report won't be printed in color.

NOTE: If the printing color is set to color, but a black-and-white printer is used, the report printed will be illegible.

8. Select **Background grid**, and the background grid will be printed in the report.

Deselect **Background grid**, and the background grid won't be printed in the report.

9.5 Output File Setup

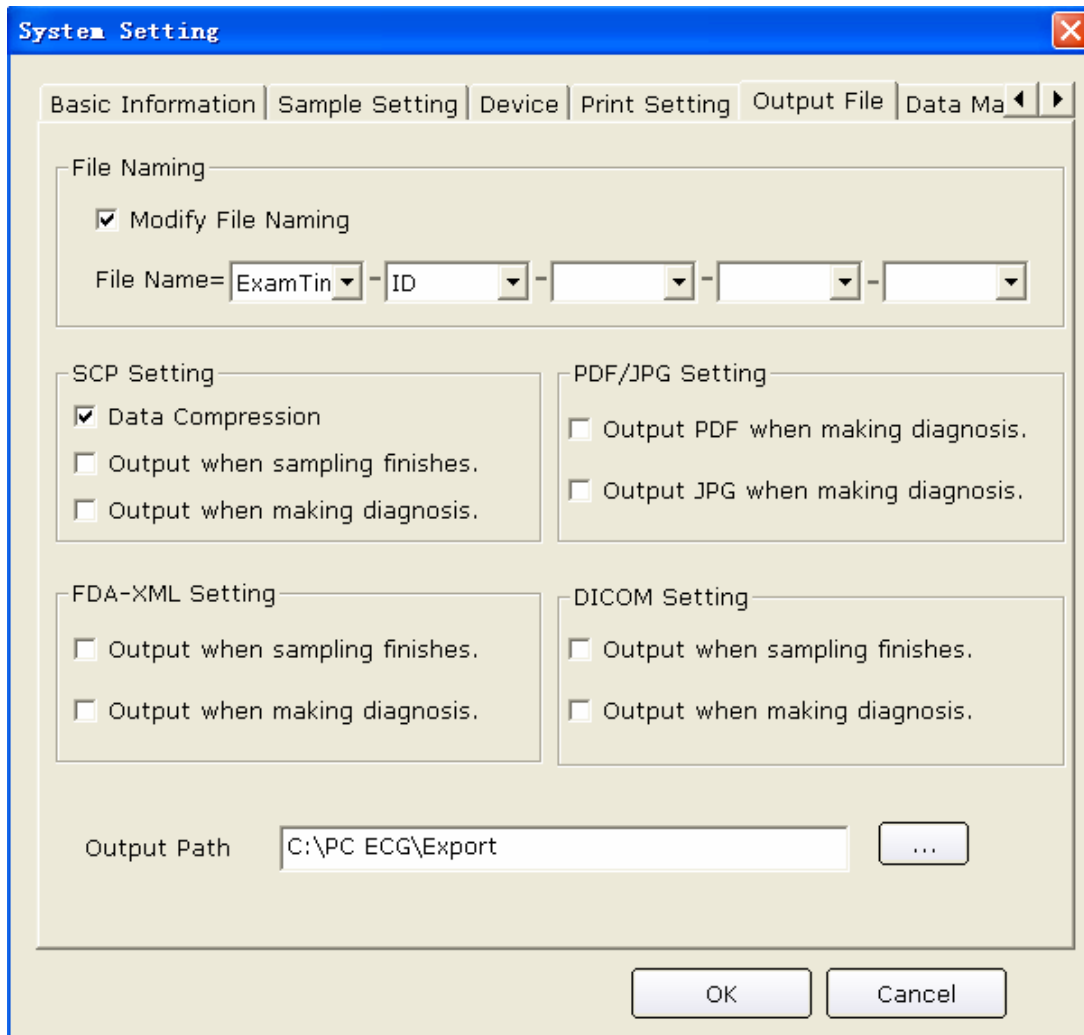


Figure 9-5 Output File Setup Window

9.5.1 File Naming

The default file name is Exam Time-ID, and a “-” exists between every two fields. You can also modify the file name manually, such as Name-ID-Exam Time. Each field includes ID, name, exam time, age and sex items, you can randomly use these items to combine a file name, but you should select at least one item as a file name.

NOTE: When you select **FirstName/LastName** in the **Print Setting** window, name will be divided into two parts.

When the file name is empty, the system will give hint information.

9.5.2 Setting PDF/JPG

Select **Output PDF when making diagnosis**, the system will automatically output files in PDF format when making diagnoses.

Select **Output JPG when making diagnosis**, the system will automatically output files in JPG format when making diagnoses.

9.5.3 Setting SCP

Select **Data Compression**, the system will automatically output files in SCP format of data compression.

Deselect **Data Compression**, the system will output files in SCP format without data compression.

Select **Output when sampling finishes**, the system will automatically output files in SCP format when sampling finishes.

Deselect **Output when sampling finishes**, the system will not output files in SCP format when sampling finishes.

Select **Output when making diagnosis**, the system will automatically output files in SCP format when making diagnoses.

Deselect **Output when making diagnosis**, the system will not output files in SCP format when making diagnoses.

9.5.4 Setting FDA-XML

Select **Output when sampling finishes**, the system will automatically output files in FDA-XML format when sampling finishes.

Deselect **Output when sampling finishes**, the system will not output files in FDA-XML format when sampling finishes.

Select **Output when making diagnosis**, the system will automatically output files in FDA-XML format when making diagnoses.

Deselect **Output when making diagnosis**, the system will not output files in FDA-XML format when making diagnoses.

9.5.5 Setting DICOM

Select **Output when sampling finishes**, the system will automatically output files in DICOM format when sampling finishes.

Deselect **Output when sampling finishes**, the system will not output files in DICOM format when sampling finishes.

Select **Output when making diagnosis**, the system will automatically output files in DICOM format when making diagnoses.

Deselect **Output when making diagnosis**, the system will not output files in DICOM format when making diagnoses.

9.5.6 Specifying the Output Path

Click on the ... button in the **Output File** window (Figure 9-5) to assign the output path.

9.6 Data Maintenance Setup

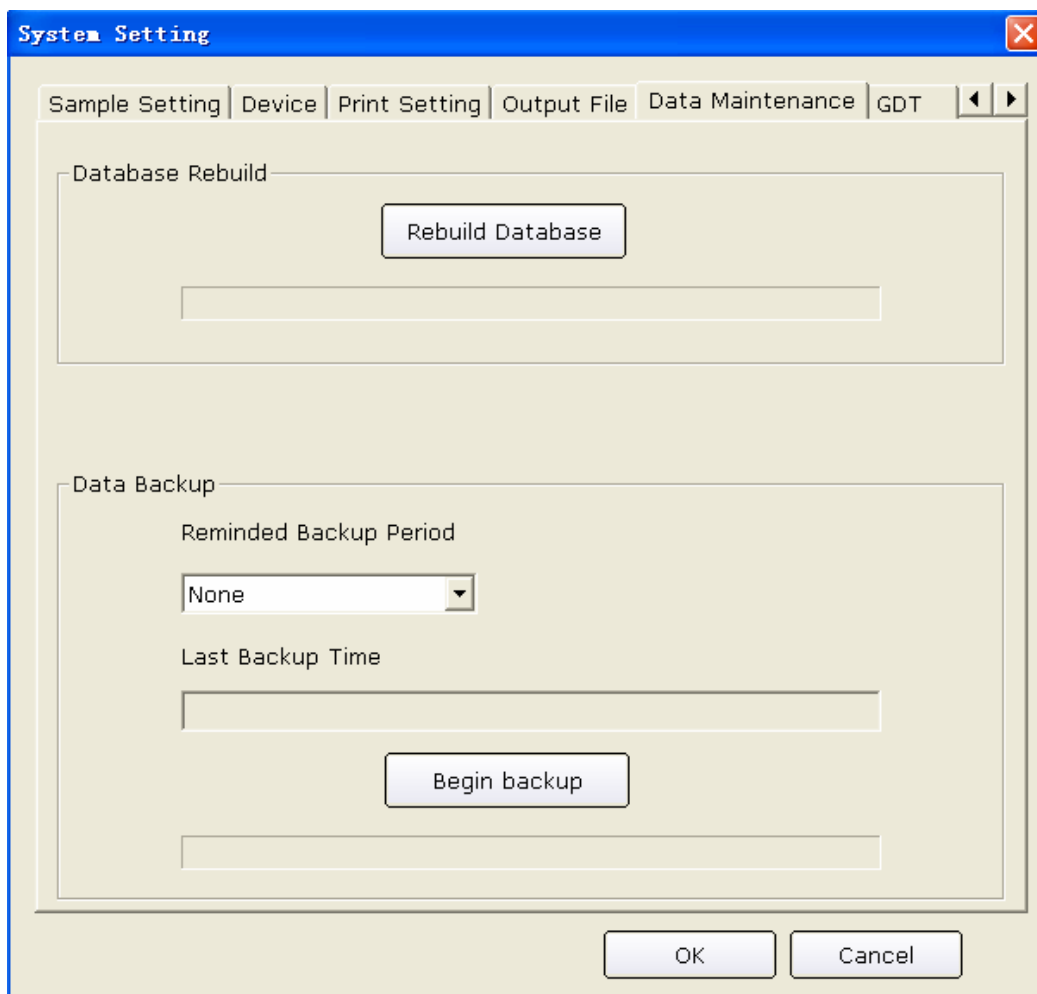
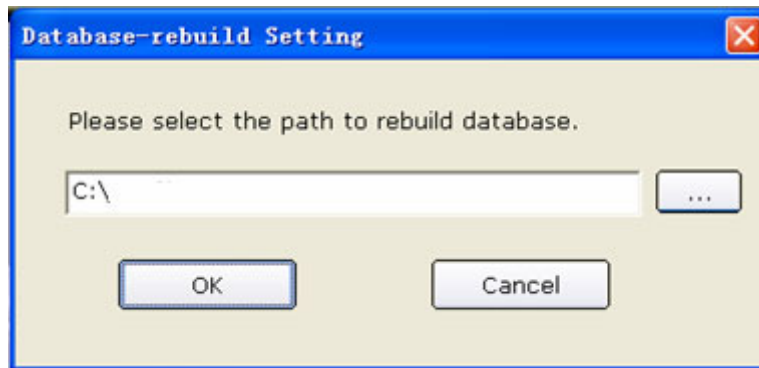


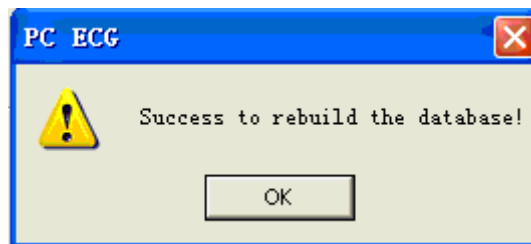
Figure 9-6 Data Maintenance Window

9.6.1 Database Rebuild

You can rebuild the database to avoid losing data because of damaged data files. Click on the **Rebuild Database** button in the **Data Maintenance** window, and then you can select the path to rebuild database. You cannot enter the path manually.



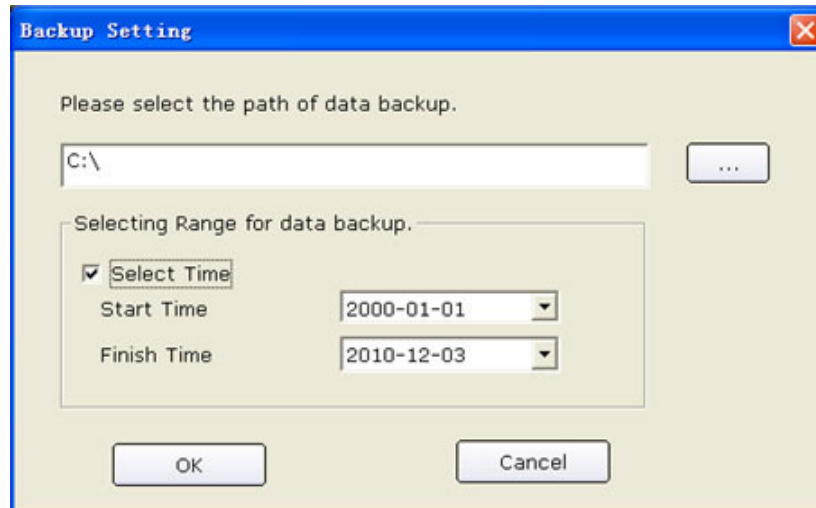
After rebuilding the path successfully, hint information will be displayed.



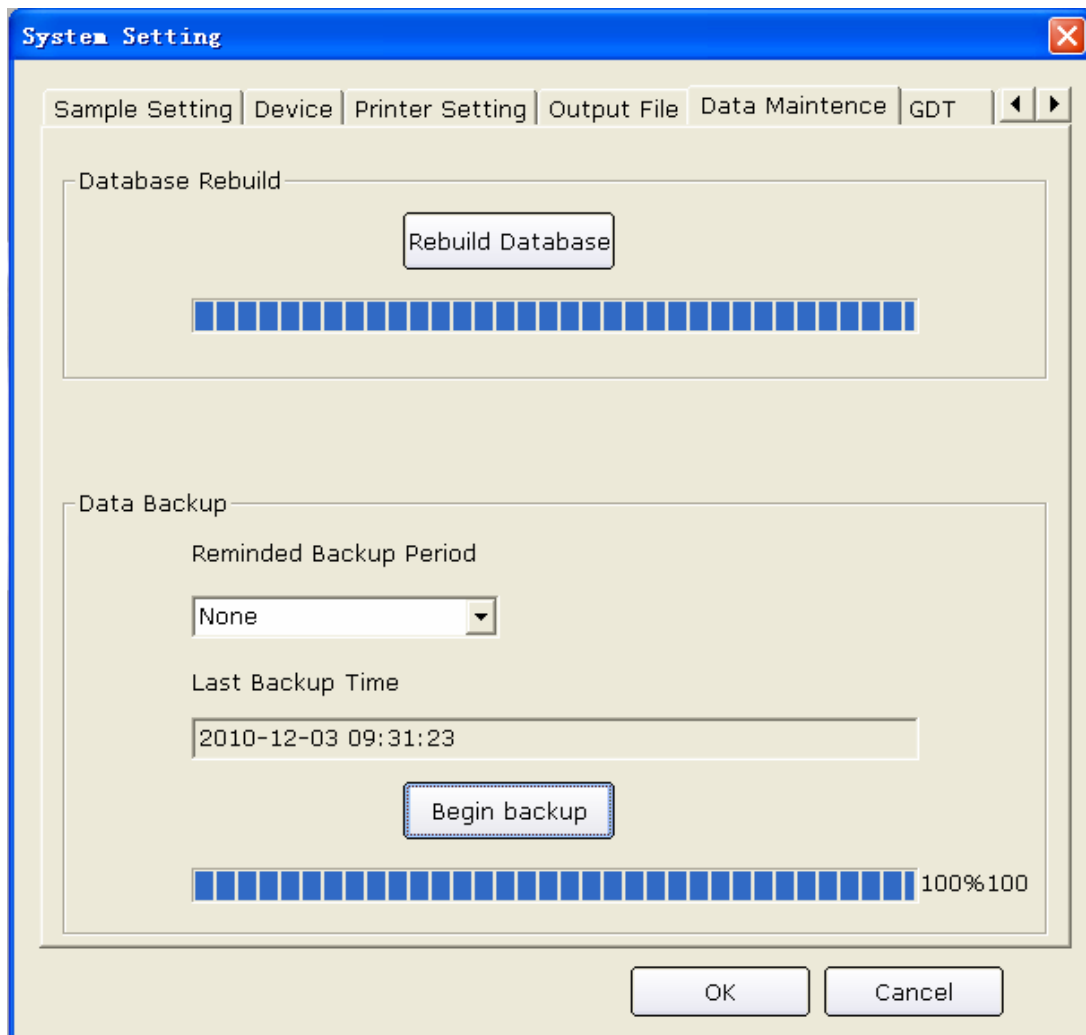
9.6.2 Database Backup

You can also make a backup for the data files to avoid your data files being damaged or missing. Click on the **Begin backup** button in the **Data Maintenance** window, and then you can select the path of data backup. You should select the path of a disk with enough space. Otherwise, the system will prompt you to change the path.

If the **Select Time** in the **Backup Setting** window is selected, the system will back up the data files from the start time to the finish time. If the **Select Time** is not selected, the system will back up all the data files.

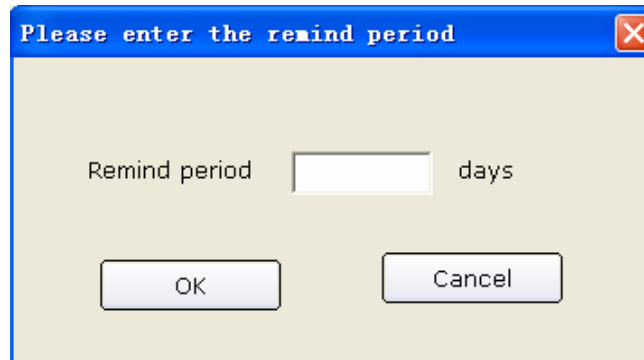


Click on the **OK** button in the **Backup Setting** window, the system will begin backup. You can check the backup status according to the progress bar or you can stop backup at any times.



The system will back up the data files for the latest time if you do not change the path.

You can also set the reminded backup period to remind you back up the data files at any time. The default system reminded period is None, you can also select 7 days, 14 days, 30 days or you can define it manually.



9.7 GDT Setup

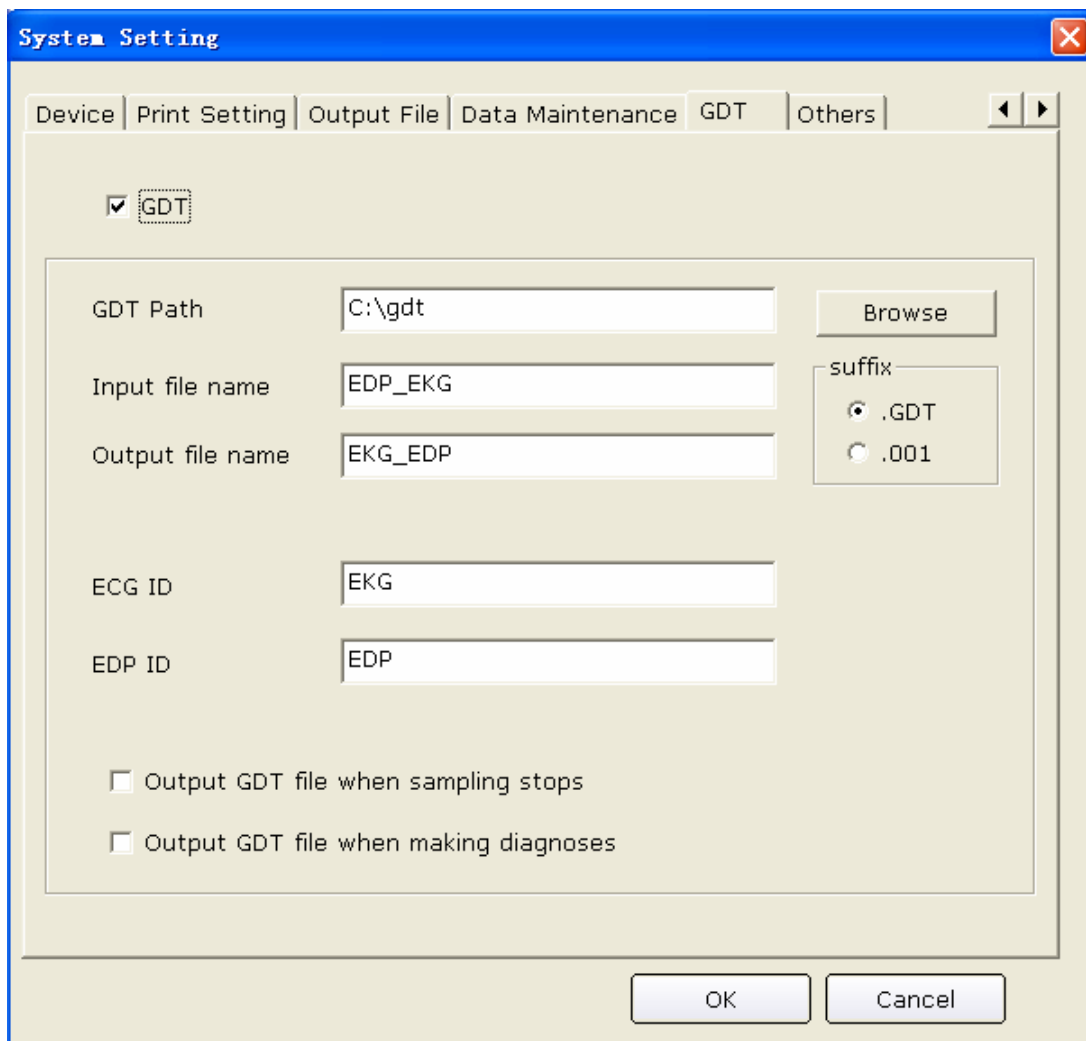


Figure 9-7 GDT Setup Window

Select **GDT** to enable GDT features.

Click on the **Browse** button, and then appoint the path to exchange files with EDP.

Fill in the **Input file name** textbox to set command file name assigned by EDP to the PC ECG system.

Fill in the **Output file name** textbox to set data file name that is used by the PC ECG system to transmit the result data to EDP.

Enter ECG ID to set GDT ID assigned to the system which will be entered in field 8315 or 8316 in the GDT protocol.

Enter EDP ID to set GDT ID of the EDP system which will be entered in field 8315 or 8316 in the GDT protocol.

Select **Output GDT file when sampling stops**, the system will automatically output GDT files when sampling stops.

Select **Output GDT file when making diagnoses**, the system will automatically output GDT files when making diagnoses.

9.8 Other Setup

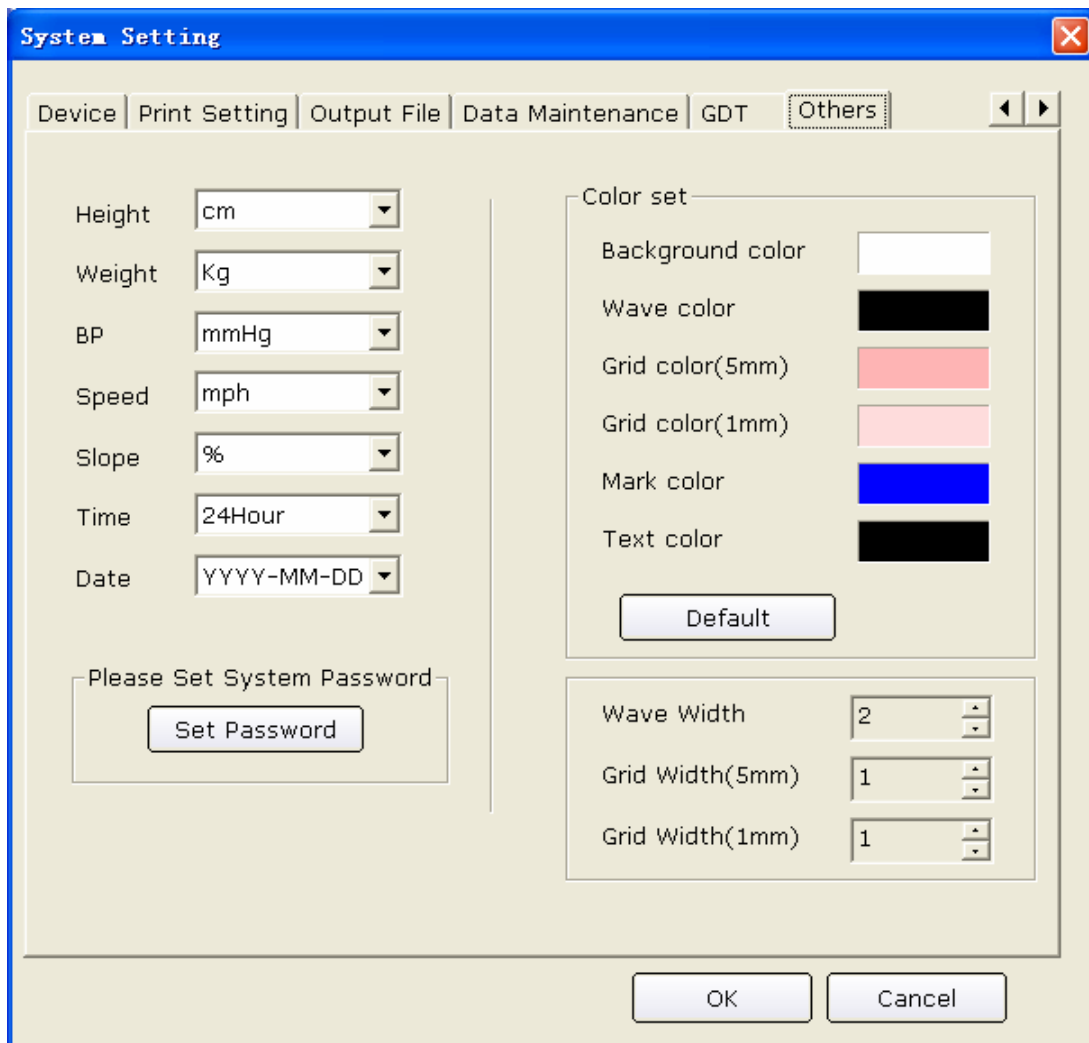


Figure 9-8 Other Setup Window

9.8.1 Setting Unit and Color

Set the height unit to **cm**, **inch** or **mm**.

Set the weight unit to **Kg**, **g** or **Pound**.

Set the BP unit to **kPa** or **mmHg**.

Set the speed unit to **Km/h** or **mph**.

Set the grade unit to **%** or **degree**.

Set the time mode to **24Hour** or **12Hour**.

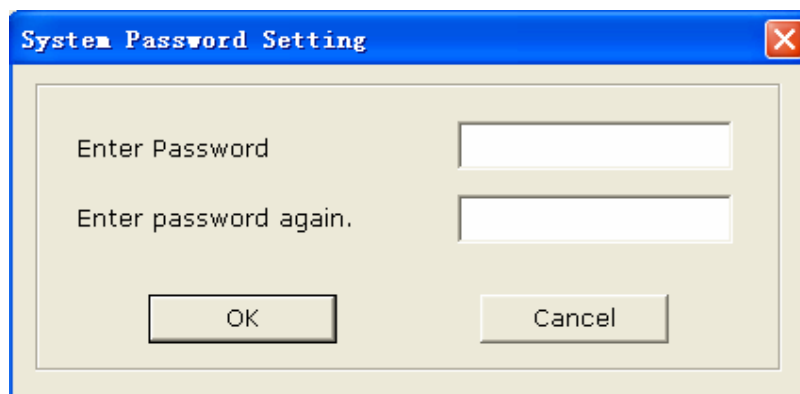
Set the date mode to **MM-DD-YYYY**, **DD-MM-YYYY** OR **YYYY-MM-DD**.

Set the color of the background, waves, grid (5mm), grid (1mm), mark and text. If you want to change a color, double-click on the color block to display the **Color** window, and then you can select your favorite color.

Click on the **Default** button to restore the default colors.

9.8.2 Setting System Password

You can set a system password to avoid the system setting being modified. Click on the **Set Password** button in the **Others** window, enter the same password for twice, and then the system password is set successfully.



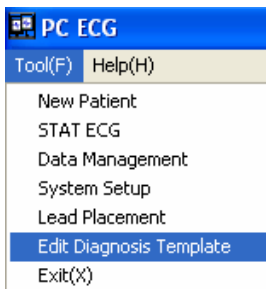
After a successful password setting, you should have a correct password to enter the **System Setting** window. Otherwise, the system will give hint information to prevent your access.

9.8.3 Setting Wave Width and Grid Width

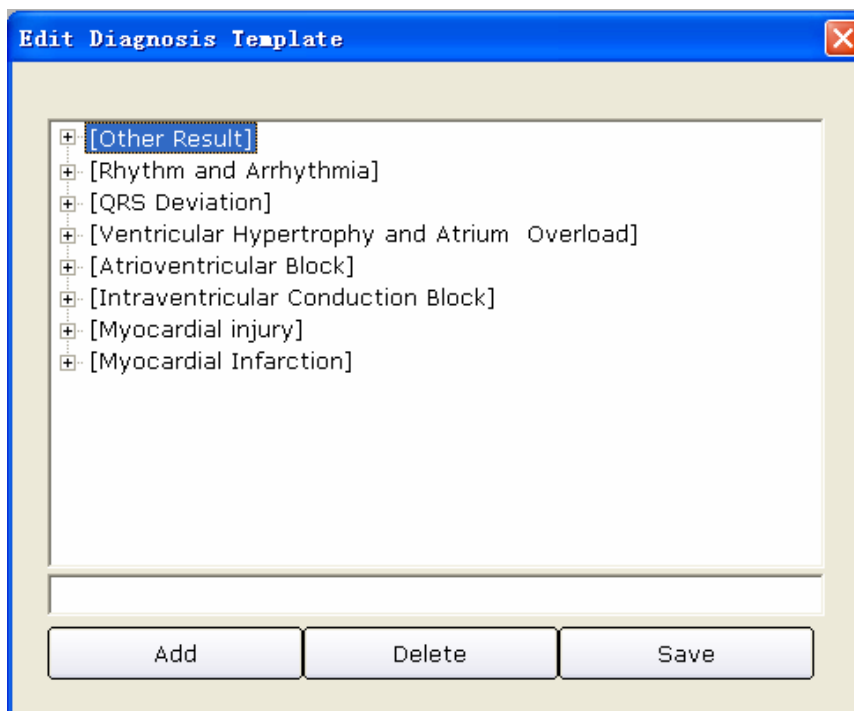
You can adjust **Wave Width**, **Grid Width (5mm)** and **Grid Width (1mm)** of report by using the up or down arrow. The adjustable range is: 1~5.

NOTE: The width may vary with the type of printer.

9.9 Modifying the Glossary

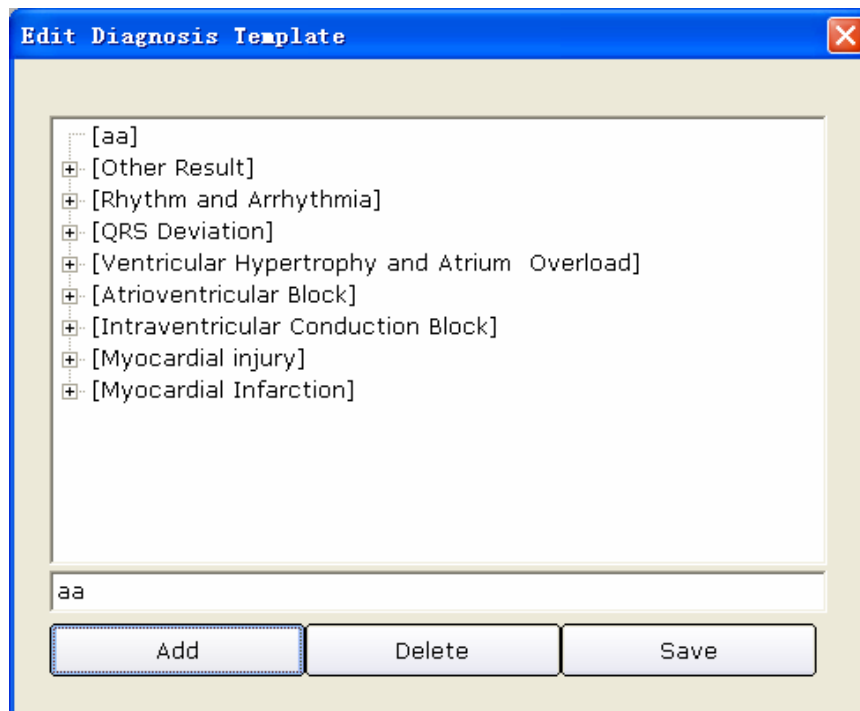


Click on **Edit Diagnosis Template** from the **Tool (F)** pull-down list on the main screen (Figure 6-1), and then the **Edit Diagnosis Template** window appears.



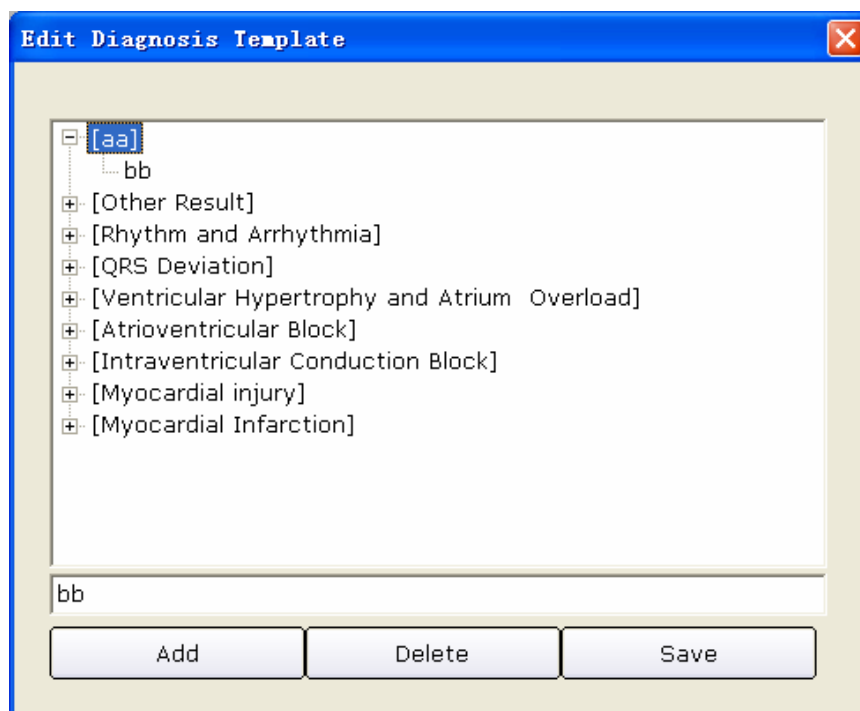
1. Adding an item

Enter a diagnosis item, such as **aa** in the textbox, and then click on the **Add** button. The added item will be displayed in the **Edit Diagnosis Template** window.



2. Adding a subitem

Click on the item you wanted to add a subitem, enter a diagnosis subitem, such as **bb** in the textbox, and then click on the **Add** button. The added subitem will be displayed under **aa**.



3. Deleting an item

Click on the item you wanted to delete from the **Edit Diagnosis Template** window, and then click on the **Delete** button to delete this item.

4. Save the settings

Click on the **Save** button to save these modifications.

Chapter 10 Hint Information

Hint information and the corresponding causes provided by the system are listed as follows.

Table 10-1 Hint Information and Causes

Hint Information	Causes
Lead off: X	Electrodes fall off the patient or the patient cable falls off the ECG sampling box.
It is pre-sampling now, please click on 'Start' to begin recording.	During the pre-sampling course
Resting ECG is sampling now!	During the sampling course of Resting ECG
Can't detect the Sentinel, enter DEMO or not?	The sentinel is not inserted.
The Sentinel is not compatible, enter DEMO or not?	The sentinel is incorrect.
Hint: Please make sure the USB line has been connected. If possible, please re-connect it!	<p>The USB cable is disconnected or the communication between the ECG sampling box and the serial port is interrupted.</p> <ol style="list-style-type: none"> 1. Reconnect the ECG sampling box to the PC. 2. Click on the Device tab in the System Setting window of the PC ECG system, and check whether the sampling device is set correctly.
Communication error! Please check the USB cable!	The USB cable falls off the PC during the sampling process.
It is connecting now, please wait...	DX12 transmitter is connecting to DX12 receiver.
Can't find the corresponding Bluetooth sampling device, please make sure the device is on.	Fail to connect with DX12 receiver.
Battery of sampling device is weak, please change the battery after the test.	Battery of DX12 transmitter is low.
Battery is weak, the sampling device is closing.	Battery of DX12 transmitter is low.

Sampling Device is in sleep mode, please press "Power" to wake it up.	DX12 transmitter is in sleep mode.
Overload	The direct current offset voltage on an electrode is too high.
Sorry, Can not Connect to the Database!	MSDE 2000 or SQL Server 2005 Express is not started up.
Fail to create database!	The system fails to create database.
Fail to open the treadmill (ergometer) port! Please make sure the treadmill (ergometer) has been connected to the computer and the port setting is right	Fail to open the COM port which controls the treadmill/ergometer. Reconnect the treadmill/ergometer to the PC, and set the COM port correctly.
Fail to open the BP monitor port! Please make sure the BP monitor has been connected to the computer and the Port set is right!	Fail to open the COM port which controls the blood pressure. Reconnect the BP monitor to the PC, and set the COM port correctly.
The current HR has exceeded the target HR!	Current heart rate value exceeds the target heart rate value.
The diastolic BP has exceeded the normal range!	Diastolic blood pressure exceeds the normal BP range.
The systolic BP has exceeded the normal range!	Systolic blood pressure exceeds the normal BP range.

According to IEC/EN 60601-1-8, the characteristics of the visual alarm signals (hint information) are listed in Table 10-2.

Table 10-2 Characteristics of Visual Alarm Signals (Hint Information)

Alarm Category	Indicator Color	Flashing Frequency	Duty Cycle
LOW	Yellow	Constant (on)	100%

Chapter 11 Cleaning, Care and Maintenance

CAUTION

Turn off the system power and drag the power cable out from the socket before cleaning or disinfection.

11.1 Cleaning and Maintaining the Treadmill

Daily Cleaning and Maintenance

1. Wipe the treadmill with a clean soft cloth to remove dust, moisture and sweat stain.
2. Wipe the handrail of the treadmill with a clean soft cloth damped in non-caustic neutral detergent.
3. Do not pour or spray detergent onto the treadmill directly.

Weekly Cleaning and Maintenance

1. Clean dust around the treadmill with a dust-collector.
2. Check whether the emergency stop switch is valid.
3. Check the tightness degree of the running belt.

Semiyearly Cleaning and Maintenance

1. Lubricate the screws.
2. Valuate the state of the treadmill.

11.2 Cleaning and Maintaining the Patient Cable and Reusable Electrodes

WARNING

Failure on the part of the responsible individual hospital or institution employing this equipment to implement a satisfactory maintenance schedule may cause undue equipment failures and possible health hazards.

- ◆ Clean the patient cable with a clean soft cloth. Do not use the detergent containing alcohol to clean the patient cable.
- ◆ Integrity of the patient cable, including the main cable and lead wires, should be checked regularly. Make sure that it is conductible.

- ◆ Do not drag or twist the patient cable with excessive stress while using it. Hold the connector plugs instead of the cable when connecting or disconnecting the patient cable.
- ◆ Align the patient cable to avoid twisting, knotting or crooking at a closed angle while using it.
- ◆ Store the lead wires in a big wheel.
- ◆ Once damage or aging of the patient cable is found, replace it with a new one immediately.

Remove the remainder gel from the electrodes with a clean soft cloth first. Take suction bulbs and metal cups of chest electrodes apart, and take clamps and metal parts of limb electrodes apart. Clean them in warm water and make sure that there is no remainder gel. Dry the electrodes with a clean dry cloth or air dry naturally.

CAUTION

1. The device and accessories are to be disposed of according to local regulations after their useful lives. Alternatively, they can be returned to the dealer or the manufacturer for recycling or proper disposal.
 2. The disposable electrodes can only be used for one time.
-
-

11.3 Disinfection

To avoid permanent damage to the equipment, disinfection can be performed only when it is considered as necessary according to your hospital's regulations.

Before disinfection, clean the equipment first. Then wipe the surfaces of the unit and the patient cable with hospital standard disinfectant.

CAUTION

Do not use chloric disinfectant such as chloride, sodium hypochlorite etc.

Chapter 12 Accessories

WARNING

Only the patient cable and other accessories supplied by the manufacturer can be used. Or else, the performance and electric shock protection can not be guaranteed.

Table 12-1 Standard Accessory List for Wired System

Accessory	Part Number
DP12 ECG Sampling Box	02.01.210039
Sentinel / USB	01.18.047225
Resting ECG External USB Cable	01.13.036134
DP12 Patient Cable / European Standard	01.57.106902
DP12 Patient Cable / American Standard	01.57.107048
Limb Electrode	01.57.040162
Chest Electrode	01.57.040163
Portable Bag	11.56.078136

Table 12-2 Standard Accessory List for Wireless System

Accessory	Part Number
PC ECG&Stress ECG (DX12) Transmitter	02.06.260163
PC ECG&Stress ECG (DX12) Receiver	02.06.260164
Exercise ECG External USB Cable	01.13.036135
Sentinel	01.18.047229
SE-1010 PC ECG software	02.01.210065
Burglar Lock	11.18.078205
DX12 Patient Cable / European Standard	01.57.471030-10
DX12 Patient Cable / American Standard	01.57.471055-10
Excell Alkaline AA LR6 1.5V	01.21.064086
Disposable electrodes	11.57.471046
DX12 Belt	01.57.471054-10
Portable Bag	11.56.078136

Table 12-3 Optional Accessory List

Accessory	Part Number
Sentinel / USB	01.18.047229
Patient Cable for Exercise ECG (only for Wired ECG System)	01.57.109850
Resting ECG External USB Cable	01.13.036134
Disposable Frosting Film for Skin Preparation	01.57.107418
MSB1212 Disposable Electrode	01.57.040171
Exercise ECG External USB Cable	01.13.036135
Computer Lenovo, Qitian M6900	11.18.052208
Snap/Banana Socket Adapter (only for Wired ECG System)	01.13.107449
Bar Code Reader Z-3152SR (U)	01.18.052267
Bar Code Reader LAB 1000	11.23.068003

Chapter 13 Warranty & Service

13.1 Warranty

EDAN warrants that EDAN's products meet the labeled specifications of the products and will be free from defects in materials and workmanship that occur within warranty period.

The warranty is void in cases of:

- a) damage caused by mishandling during shipping.
- b) subsequent damage caused by improper use or maintenance.
- c) damage caused by alteration or repair by anyone not authorized by EDAN.
- d) damage caused by accidents.
- e) replacement or removal of serial number label and manufacture label.

If a product covered by this warranty is determined to be defective because of defective materials, components, or workmanship, and the warranty claim is made within the warranty period, EDAN will, at its discretion, repair or replace the defective part(s) free of charge. EDAN will not provide a substitute product for use when the defective product is being repaired.

13.2 Contact information

If you have any question about maintenance, technical specifications or malfunctions of devices, contact your local distributor.

Alternatively, you can send an email to EDAN service department at: support@edan.com.cn.

Chapter 14 Recommended Optional Accessories

Treadmill:

Model: TM-400

Manufacturer: EDAN INSTRUMENTS, INC. China

CE marking

Model: Valiant

Manufacturer: Lode B.V. The Netherlands

CE marking

Model: h/p/cosmos (all medical models) with coscom interface

Manufacturer: Full Vision Inc. USA

CE marking

Model: mercury med 4.0, mercury 4.0

Manufacturer: h/p/cosmos sports & medical gmbh Germany

CE marking

Ergometer:

Model: sana bike 120F, sana bike 150F, sana 250F

Manufacturer: ergosana gmbh Germany

CE marking

Model: ergoselect 100P/100K, ergoselect 200P/200K

Manufacturer: ergoline gmbh Germany

CE marking

Model: Corival

Manufacturer: Lode B.V. The Netherlands

CE marking

STRESS BP:

Model: Tango+

Manufacturer: SunTech Medical Inc. USA

CE Certificate and FDA 510(k) clearance

Isolating Transformer:

Model: ES710

Manufacturer: BenDer Inc. Deutschland

Electrical Outlet:

Power Consumption: no less than 4500VA

Special use for medical equipment

Printer:

Model: HP2010, HP2035

Manufacturer: HP Company, USA

Model: CANON iP1980

Manufacturer: CANON Company, Japan

WARNING

1. The electrical outlet and the isolating transformer shall only be used for supplying power to the part of the system.
 2. It will harm the wall outlet to connect the non-medical electrical equipment of the PC ECG system directly to the wall outlet, because the non-medical electrical equipment of the system is intended to be powered by using the electrical outlet and the isolating transformer.
 3. An additional multiple portable socket-outlet or extension cord shall not be connected to the system.
 4. The electrical outlet and the isolating transformer shall not be placed on the floor.
-

Appendix 1 Technical Specifications

A1.1 Safety Specifications

Comply with:	IEC/EN 60601-1+A1+A2, IEC/EN 60601-1-2+A1, IEC/EN60601-2-25, ANSI/AAMI EC11, IEC/EN60601-2-51	
Anti-electric-shock type:	Class II	
Anti-electric-shock degree:	Type CF with defibrillation-proof	
Degree of protection against harmful ingress of water:	Ordinary equipment (Sealed equipment without liquid proof)	
Disinfection/sterilization method:	Refer to the user manual for details	
Degree of safety of application in the presence of flammable gas:	Equipment not suitable for use in the presence of flammable gas	
Working mode:	Continuous operation	
EMC:	Group 1, Class A	
Patient Leakage Current:	NC	<10 μ A (AC) / <10 μ A (DC)
	SFC	<50 μ A (AC) / <50 μ A (DC)
Patient Auxiliary Current:	NC	<10 μ A (AC) / <10 μ A (DC)
	SFC	<50 μ A (AC) / <50 μ A (DC)

A1.2 Environment Specifications

	Transport & Storage	Working
Temperature:	DP12 ECG sampling box: -40°C (-40°F) ~ +55°C (+131°F) DX12 ECG sampling box: -20°C (-4°F)~+55°C (+131°F)	+5°C (+41°F) ~ +40°C (+104°F)
Relative Humidity:	25%~93% Non-Condensing	25%~80% Non-Condensing
Atmospheric Pressure:	700hPa ~1060hPa	860hPa ~1060hPa

A1.3 Physical Specifications

Dimensions	DP12 ECG sampling box: 148 mm (L) × 100 mm (W) × 40 mm (H) (5.8in×3.9in×1.6in)
	DX12 transmitter: 63mm(L)×107mm(W) ×23mm(H) (2.5in×4.2in×0.9in)
	DX12 receiver: 155mm(L)×100mm(W)×30mm(H) (6.1in×3.9in×1.2in)
Weight	DP12 ECG sampling box: Approx. 210g
	DX12 transmitter: Approx. 113g (not including battery)
	DX12 receiver: Approx. 173g

A1.4 Power Supply Specifications

Power Supply:	PC	Operating Voltage: 110V-240V~
		Operating Frequency: 50 Hz/60 Hz
	DP12 ECG Sampling Box	DC 5V
		Input Power: 1 VA(MAX), 0.5 VA(MIN)
	DX12 transmitter	Input Power: 2x1.5V Excell Alkaline AA IEC LR6; Operation life of battery ≥ 12 hours
	DX12 receiver	DC 5V
Input Power: 350mW		

A1.5 Performance Specifications

Display	
Display Content	System name, Patient ID, Patient name Heart rate, Display mode, Printing mode Speed, Gain, Lowpass Filter Hint information ECG waves
Recording	
Recording Paper:	A4, Letter
Paper Width:	210*295mm (A4), 216*279mm (Letter)

Paper Speed:	5 mm/s, 10 mm/s, 12.5 mm/s, 25 mm/s, 50 mm/s ($\pm 3\%$)
Record message:	Date, Time, Printing Speed, Filter, Symbol, Heart Rate, Patient ID, Sex, Age, Lead Mark, Lead Wave, Average Template Wave or Rhythm Lead Wave, Measurement Result and Interpretation Information Result (option) etc.
Channel:	3 / 6 / 12 channels, auto baseline adjustment
HR Recognition	
Technique:	Peak-peak detection
HR Range:	30 BPM ~300 BPM
Accuracy:	± 1 BPM
Memory	
Memory:	Storage amount depends on PC machine
ECG Sampling Box Performance	
Leads Mode:	12 standard leads/ Cabrera leads
Acquisition Mode:	simultaneously 12 leads
Sample Frequency:	DP12 ECG sampling box: 1,000 /sec/channel
	DX12 transmitter: 10,000 /sec/channel (sampling) 500 /sec/channel (analysis)
A/D Resolution:	DP12 ECG sampling box: 24 bits
	DX12 transmitter: 18 bits
Time Constant:	≥ 3.2 s
Frequency Response:	0.05 Hz ~ 150 Hz (-3 dB)
Gain:	2.5 mm/mV, 5 mm/mV, 10 mm/mV, 20 mm/mV
Input Impedance:	DP12 ECG sampling box ≥ 50 M Ω (10Hz)
	DX12 transmitter ≥ 20 M Ω (10Hz)
Input Circuit Current:	≤ 0.05 μ A
Input Voltage Range	$< \pm 5$ mVpp
Calibration Voltage:	1 mV $\pm 2\%$
DC Offset Voltage	DP12 ECG sampling box: ± 600 mV
	DX12 transmitter: ± 500 mV
Noise:	DP12 ECG sampling box ≤ 12.5 μ Vp-p
	DX12 transmitter ≤ 15 μ Vp-p

Filter	Work Frequency
	DFT Filter: weak/strong
	LOWPASS Filter: 25 Hz / 35 Hz / 45 Hz / 75 Hz / 100 Hz / 150 Hz
CMRR	DP12 ECG sampling box ≥ 110 dB
	DX12 transmitter ≥ 100 dB
Pacemaker Detection	
Amplitude	DP12 ECG sampling box: ± 2 to ± 700 mV
	DX12 transmitter: ± 2 to ± 500 mV
Width	0.1 to 2.0 ms
Sampling Frequency	10,000 /sec/channel

NOTE: Test the accuracy of input signal reproduction according to the methods described in clause 4.2.7.2 in ANSI/AAMI EC11:1991/(R) 2001/(R) 2007, and the result complies with clause 3.2.7.2 in ANSI/AAMI EC11:1991/(R) 2001/(R) 2007.

Appendix 2 EMC Information

Guidance and manufacture's declaration - electromagnetic emissions- for all EQUIPMENT and SYSTEMS

Guidance and manufacture's declaration - electromagnetic emission		
SE-1010 PC ECG is intended for use in the electromagnetic environment specified below. The customer or the user of SE-1010 PC ECG should assure that it is used in such an environment.		
Emission test	Compliance	Electromagnetic environment - guidance
RF emissions CISPR 11	Group 1	SE-1010 PC ECG uses RF energy only for its internal function. Therefore, its RF emissions are very low and are not likely to cause any interference in nearby electronic equipment.
RF emission CISPR 11	Class A	SE-1010 PC ECG is suitable for use in all establishments, other than domestic and those directly connected to the public low-voltage power supply network that supplies buildings used for domestic purposes.
Harmonic emissions IEC 61000-3-2	Not applicable	
Voltage fluctuations/ flicker emissions IEC 61000-3-3	Not applicable	


**Guidance and manufacture's declaration - electromagnetic immunity -
for all EQUIPMENT and SYSTEMS**

Guidance and manufacture's declaration - electromagnetic immunity			
SE-1010 PC ECG is intended for use in the electromagnetic environment specified below. The customer or the user of SE-1010 PC ECG should assure that it is used in such an environment.			
Immunity test	IEC 60601 test level	Compliance level	Electromagnetic environment - guidance
Electrostatic discharge (ESD) IEC 61000-4-2	±6 kV contact ±8 kV air	±6 kV contact ±8 kV air	Floors should be wood, concrete or ceramic tile. If floor are covered with synthetic material, the relative humidity should be at least 30%.
Electrical fast transient/burst IEC 61000-4-4	±2 kV for power supply lines	Not applicable	Mains power quality should be that of a typical commercial or hospital environment.
Surge IEC 61000-4-5	±1 kV line to line ±2 kV line to ground	Not applicable	Mains power quality should be that of a typical commercial or hospital environment.
Power frequency (50Hz/60Hz) magnetic field IEC 61000-4-8	3A/m	3A/m	Power frequency magnetic fields should be at levels characteristic of a typical location in a typical commercial or hospital environment.
Voltage dips, short interruptions and voltage variations on power supply input lines IEC 61000-4-11	<5% U_T (>95% dip in U_T) for 0.5 cycle 40% U_T (60% dip in U_T) for 5 cycles	Not applicable	Mains power quality should be that of a typical commercial or hospital environment. If the user of SE-1010 PC ECG requires continued operation during power mains interruptions, it is recommended that

	<p>70% U_T (30% dip in U_T) for 25 cycles</p> <p><5% U_T (>95% dip in U_T) for 5 sec</p>		SE-1010 PC ECG be powered from an uninterruptible power supply or a battery.
NOTE U_T is the a.c. mains voltage prior to application of the test level.			

**Guidance and manufacture's declaration - electromagnetic immunity -
for EQUIPMENT and SYSTEMS that are not LIFE-SUPPORTING**

Guidance and manufacture's declaration - electromagnetic immunity			
SE-1010 PC ECG is intended for use in the electromagnetic environment specified below. The customer or the user of SE-1010 PC ECG should assure that it is used in such an environment.			
Immunity test	IEC 60601 test level	Compliance level	Electromagnetic environment - guidance
Conducted RF IEC61000-4-6	3 V_{rms} 150 kHz to 80 MHz	3 V_{rms}	<p>Portable and mobile RF communications equipment should be used no closer to any part of SE-1010 PC ECG, including cables, than the recommended separation distance calculated from the equation applicable to the frequency of the transmitter.</p> <p>Recommended separation distance</p> $d = 1.2\sqrt{P}$ $d = 1.2\sqrt{P} \quad 80 \text{ MHz to } 800 \text{ MHz}$
Radiated RF IEC61000-4-3	3 V/m 80 MHz to 2.5 GHz	3 V/m	$d = 2.3\sqrt{P} \quad 800 \text{ MHz to } 2.5 \text{ GHz}$ <p>Where P is the maximum output power rating of the transmitter in watts (W) according to the transmitter manufacturer and d is the recommended separation distance in metres (m).</p>

			<p>Field strengths from fixed RF transmitters, as determined by an electromagnetic site survey,^a should be less than the compliance level in each frequency range.^b</p> <p>Interference may occur in the vicinity of equipment marked with the following symbol:</p> 
<p>NOTE 1 At 80 MHz and 800 MHz, the higher frequency range applies.</p> <p>NOTE 2 These guidelines may not apply in all situations. Electromagnetic propagation is affected by absorption and reflection from structures, objects and people.</p>			<p>^a Field strengths from fixed transmitters, such as base stations for radio (cellular/cordless) telephones and land mobile radios, amateur radio, AM and FM radio broadcast and TV broadcast cannot be predicted theoretically with accuracy. To assess the electromagnetic environment due to fixed RF transmitters, an electromagnetic site survey should be considered. If the measured field strength in the location in which SE-1010 PC ECG is used exceeds the applicable RF compliance level above, SE-1010 PC ECG should be observed to verify normal operation. If abnormal performance is observed, additional measures may be necessary, such as reorienting or relocating SE-1010 PC ECG.</p> <p>^b Over the frequency range 150 kHz to 80 MHz, field strengths should be less than 3 V/m.</p>

**Recommended separation distances between portable and mobile
RF communications equipment and the EQUIPMENT or SYSTEM –
for EQUIPMENT or SYSTEM that are not LIFE-SUPPORTING**

Recommended separation distances between portable and mobile RF communications equipment and SE-1010 PC ECG			
SE-1010 PC ECG is intended for use in an electromagnetic environment in which radiated RF disturbances are controlled. The customer or the user of SE-1010 PC ECG can help prevent electromagnetic interference by maintaining a minimum distance between portable and mobile RF communications equipment (transmitters) and SE-1010 PC ECG as recommended below, according to the maximum output power of the communications equipment.			
Rated maximum output power of transmitter (W)	Separation distance according to frequency of transmitter (m)		
	150 kHz to 80 MHz	80 MHz to 800 MHz	800 MHz to 2.5 GHz
	$d = 1.2\sqrt{P}$	$d = 1.2\sqrt{P}$	$d = 2.3\sqrt{P}$
0.01	0.12	0.12	0.23
0.1	0.38	0.38	0.73
1	1.2	1.2	2.3
10	3.8	3.8	7.3
100	12	12	23
For transmitters rated at a maximum output power not listed above, the recommended separation distance d in metres (m) can be estimated using the equation applicable to the frequency of the transmitter, where P is the maximum output power rating of the transmitter in watts (W) according to the transmitter manufacturer.			
NOTE 1 At 80 MHz and 800 MHz, the separation distance for the higher frequency range applies.			
NOTE 2 These guidelines may not apply in all situations. Electromagnetic propagation is affected by absorption and reflection from structures, objects and people.			

Appendix 3 Abbreviation

Abbreviation	Statement
ECG	Electrocardiograph/Electrocardiogram
VCG	Vector ECG
TVCG	Time Vector ECG
QTD	QT Dispersion
FCG	Frequency ECG
HRV	Heart Rate Variability
HFECG	High Frequency ECG
HRT	Heart Rate Turbulence
SAECG	Signal Averaged ECG
TO	Turbulence Onset
TS	Turbulence Slope
VLP	Ventricular Late Potential
HR	Heart Rate
P Dur	P-wave Duration
PR Dur	P-R Interval
QRS Dur	QRS Complexes Duration
QT/QTc	Q-T Interval of the Current Lead / Normalized QT Interval
P/QRS/T	Dominant Direction of the Average Integrated ECG Vectors
Maximum/Minimum	Ratio of Maximum RR Interval to Minimum RR Interval
SDNN	Standard Deviation of Normal to Normal Intervals
RMSSD	Root Mean Square Successive Difference
LF	Low Frequency
HF	High Frequency
LF (norm)	Standard LF Power

HF (norm)	Standard HF Power
aVF	Left Foot Augmented Lead
aVL	Left Arm Augmented Lead
aVR	Right Arm Augmented Lead
LA	Left Arm
R	Right
RA	Right Arm
RL	Right Leg
ID	Identification
AC	Alternating Current
USB	Universal Serial Bus

P/N: 01.54.106666-20

EDAN
www.edan.com.cn

EC REPRESENTATIVE

Shanghai International Holding Corp. GmbH (Europe)

Eiffestrasse 80, D-20537 Hamburg Germany

TEL: +49-40-2513175 FAX: +49-40-255726

E-mail: antonjin@yahoo.com.cn

EDAN INSTRUMENTS, INC.

3/F-B, Nanshan Medical Equipment Park, Nanhai Rd 1019#,

Shekou, Nanshan Shenzhen, 518067 P.R. CHINA

Email: info@edan.com.cn

TEL: +86-755-2689 8326 FAX: +86-755-2689 8330